

**Position Transducers
Pivot head mounting
potentiometric
up to 300 mm, IP54**

Series TEX

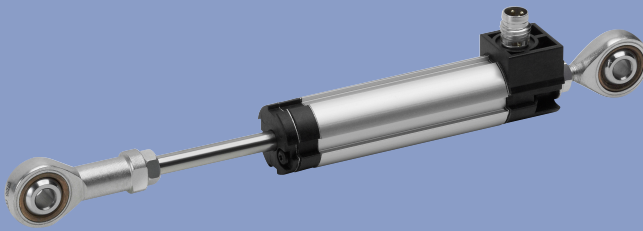

Special features

- compact dimensions
- protection class IP54
- mountable over back-lash
- free pivot heads with a large angle of free movement (up to $\pm 12,5^\circ$)
 - very long life (depending on application) up to 100 million movements
- resolution better than 0.01 mm
- outstanding linearity up to $\pm 0.05\%$
- variable mechanical customer interfaces
- cable or connector version available
- heavy-duty version IP67 see data sheet TX2

Compact design and easy to assemble via pivot heads characterize this inexpensive transducer. This transducer is suitable for various industry applications. By the simplicity of the measuring system - passive and absolute - the transducer is largely insensitive to electrical interference. The measuring value remains despite power failure.

The electrical connection can be made via a radial plug connector, a radial or axial cable. Transducers with and without restoring spring and mounting clamp, central thread or flange plates see separate data sheets TEX.

Description	
Housing	aluminium, anodized
Mounting	see drawing
Actuating rod	stainless steel (1.4305), rotatable, external thread M5
Bearings	sleeve bearing
Resistance element	conductive plastic
Wiper assembly	precious metal multi-finger wiper
Electrical connections	3-pin round connector M8x1 3-wire PUR-cable, 3x0.14 mm ² , shielded, 2 m or 5 m lengths

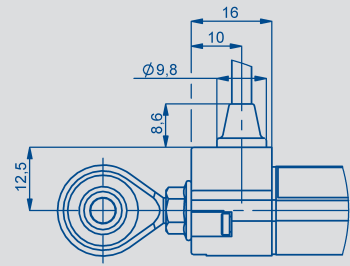
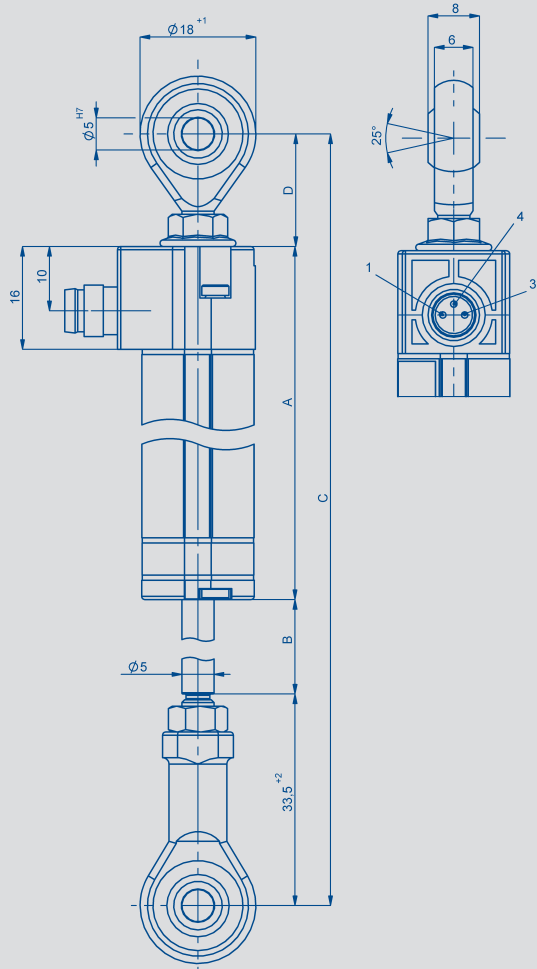
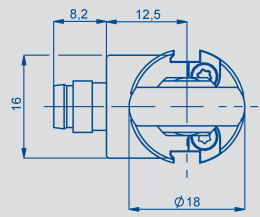

Type designations	TEX 0010	TEX 0025	TEX 0050	TEX 0075	TEX 0100	TEX 0125	TEX 0150	TEX 0175	TEX 0200	TEX 0250	TEX 0300	
Electrical Data												
Defined electrical range	10	25	50	75	100	125	150	175	200	250	300	mm
Electrical range	12	27	52	77	102	130	155	180	205	255	305	mm
Nominal resistance	1	1	2	3	4	5	6	7	8	10	12	kΩ
Resistance tolerance	20											±%
Independent linearity	0.25	0.2	0.1	0.1	0.1	0.05	0.05	0.05	0.05	0.05	0.05	±%
Repeatability	0.01											mm
Recommended operating wiper current	≤ 1											μA
Max. wiper current in case of malfunction	10											mA
Max. permissible applied voltage	42											V
Effective temperature coefficient of the output-to-applied voltage ration	typical 5											ppm/K
Insulation resistance (500 VDC)	≥10											MΩ
Dielectric strength (500 VAC, 50 Hz)	≤100											μA
Mechanical Data												
Body length (dimension A)	63	78	103	128	153	194	219	244	269	319	369	±2 mm
Mechanical stroke (dimension B)	14	29	54	79	104	132	157	182	207	257	307	±2 mm
Min. distance between pivot heads nominal (dim. C), version_15, dim. D=18 mm	114.5	129.5	154.5	179.5	204.5	245.5	270.5	295.5	320.5	370.5	420.5	
Min. distance between pivot heads nominal (dim. C), version_13, dim. D=25 mm	121.5	136.5	161.5	186.5	211.5	252.5	277.5	302.5	327.5	377.5	427.5	
Weight approx.												
cable version TEX-_-_-_-1_-002-202	111	116	126	136	146	186	196	206	216	236	256	g
connector version TEX-_-_-_-1_-002-101	79	84	94	104	114	154	164	174	184	204	224	g
Operating force horizontal	≤ 3.0 (at RT 20° C)											N
Environmental Data												
Temperature range	-40 ...+85											°C
Operating humidity range	0...95 (no condensation)											% R.H.
Vibration	5...2000 A _{max} = 0.75 a _{max} = 20											Hz mm g
Shock	50 6											g ms
Life	> 100 x 10 ⁶ typ.											movements
Operating speed	10											m/s max.
Protection class	IP54 DIN EN 60529											

Novotechnik
 Messwertaufnehmer OHG
 Postfach 4220
 73745 Ostfildern (Ruit)
 Horbstraße 12
 73760 Ostfildern (Ruit)
 Tel. +49 711 44 89-0
 Fax +49 711 44 89-118
 info@novotechnik.de
 www.novotechnik.de

© 09/2012
 Art.-No.: 062 777
 Subject to changes
 Printed in Germany

Ordering specifications

Preferred types printed in bold

T E X - 0 1 5 0 - 4 1 5 - 0 0 2 - 2 0 2

Series

Electrical version
 002: linearized

Electrical connection
 101: 3-pin round connector M8x1, radial output
 202: NT standard cable 2 m, radial output
 205: NT standard cable 5 m, radial output

Mechanical fixing
 3: Pivot heads long
 5: Pivot heads short

Mechanical version actuating rod
 1: Transducer with one-side rod and thread M5

Protection class
 4: one-side actuating rod, IP54

Electrical defined range
 Standard lengths from 0010 mm up to 0300 mm

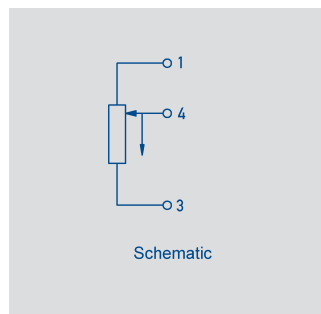
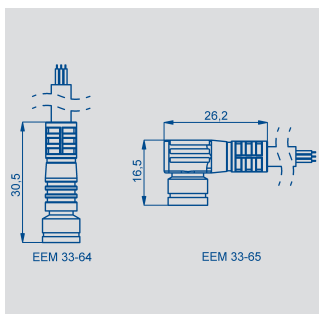

Output connector Code 101	Cable Code 202, 205	Connector with cable EEM 33-64, / -66 / -68 / -65 / -67 / -69
PIN 1	BN brown	BN brown
PIN 4	WH white	BK black
PIN 3	GN green	BU blue

Optional accessories

PUR-cable with 3-pin female connector M8x1, 3x0.34 mm², IP67, unshielded:

- 2 m lengths, EEM-33-64, P/N 005617,
- 5 m lengths, EEM-33-66, P/N 005619,
- 10 m lengths, EEM-33-68, P/N 005643.

PUR-cable with 3-pin angled female connector M8x1, 3x0.34 mm², IP67, unshielded:

- 2 m lengths, EEM-33-65, P/N 0056018,
 - 5 m lengths, EEM-33-67, P/N 005620,
 - 10 m lengths, EEM-33-69, P/N 005644
- Other cable on request.

Process-controlled indicators MAP... with display, Signal conditioner MUP.../MUK... for current supply 24 V and standardized output signals.

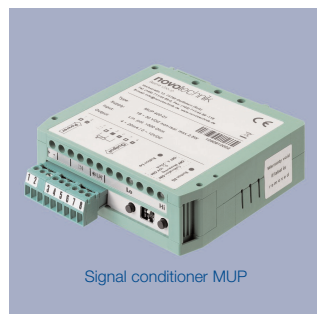

Important

All values specified in this data sheet for linearity, lifetime and temperature coefficient are only valid for a sensor used as a voltage divider with virtually no load applied to the wiper ($I_e \leq 1 \mu A$).