

General Specifications

Motor Protection: Auto Restart/Polarity Protection
 Insulation Resistance: 10M Ohm or over with a DC500V Megger
 Dielectric Withstand Voltage: AC 700V 1st
 Allowable Ambient Temperature Range:
 B80: -10 degree C ~ +60 degree C (Operating)
 B70: -10 degree C ~ +70 degree C (Operating)
 B50 ~ B60: -10 degree C ~ +50 degree C (Operating)
 B10 ~ B20: -10 degree C ~ +70 degree C (Operating)
 All Class: -40 degree C ~ +70 degree C (Storage)
 (non-condensing environment)

Material

Casing: Plastic (Black) UL94V-0
 Impeller: Plastic (Black) UL94V-0
 Lead Wire: UL1007, AWG24, +Red, -Black

2410ML product picture



2410ML characteristic curve

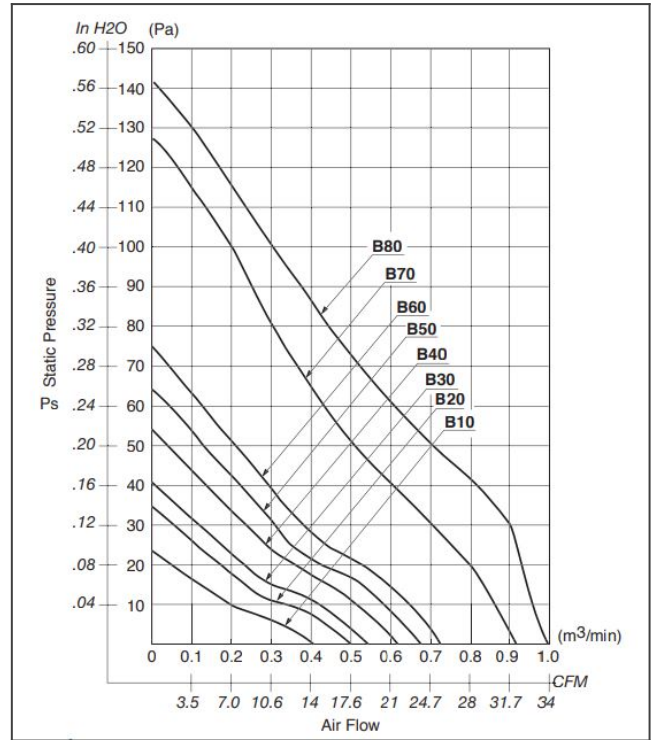

DC Fans

2410ML product drawing

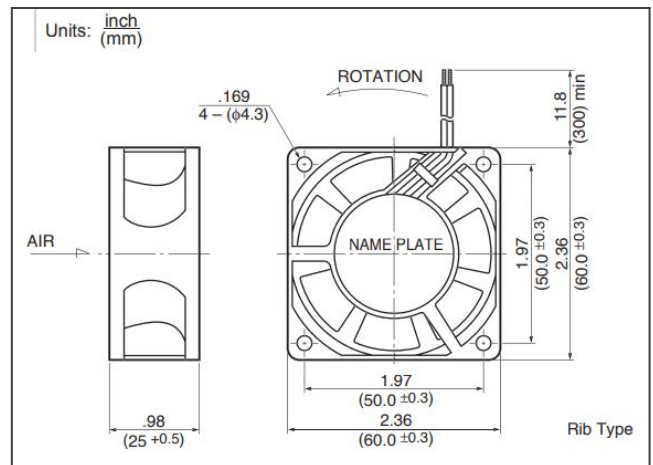

2410ML panel cut out

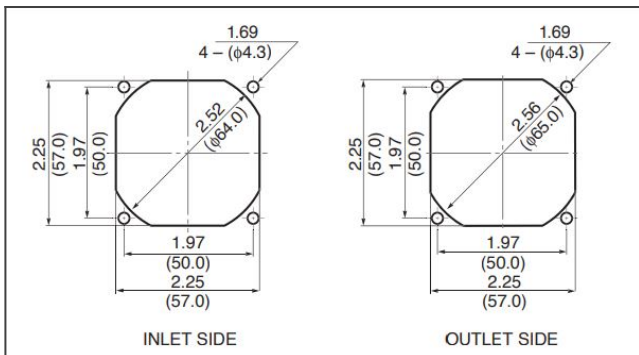

Detailed Specifications

Expected Life:	25 degree C 100,000 Hours (L10)
DC Fan:	Ball Bearing Fan
Nominal Voltage:	12[V]
Operating Voltage Lower:	6[V]
Operating Voltage Upper:	13.8[V]
Current:	0.3[A]
Input Power:	3.6[W]
Speed:	5300[min^{-1}]
Max. Air Flow:	0.71[m^3/min]
Max. Air Flow:	25[CFM]
Max. Static Pressure:	73[Pa]
Max. Static Pressure:	0.29[In H ₂ O]
Noise:	38[dB]
Mass:	65[g]
Fan Size:	60[mm]
Fan Width:	25[mm]