

SN75174 QUADRUPLE DIFFERENTIAL LINE DRIVER

SLLS039B – OCTOBER 1980 – REVISED MAY 1995

- Meets or Exceeds the Requirements of ANSI Standards EIA/TIA-422-B and RS-485 and ITU Recommendation V.11.
- Designed for Multipoint Transmission on Long Bus Lines in Noisy Environments
- 3-State Outputs
- Common-Mode Output Voltage Range of -7 V to 12 V
- Active-High Enable
- Thermal Shutdown Protection
- Positive- and Negative-Current Limiting
- Operates From Single 5-V Supply
- Low Power Requirements
- Functionally Interchangeable With MC3487

description

The SN75174 is a monolithic quadruple differential line driver with 3-state outputs. It is designed to meet the requirements of ANSI Standards EIA/TIA-422-B and RS-485 and ITU Recommendation V.11. The device is optimized for balanced multipoint bus transmission at rates up to 4 megabaud. Each driver features wide positive and negative common-mode output voltage ranges making it suitable for party-line applications in noisy environments.

The SN75174 provides positive- and negative-current limiting and thermal shutdown for protection from line fault conditions on the transmission bus line. Shutdown occurs at a junction temperature of approximately 150°C . This device offers optimum performance when used with the SN75173 or SN75175 quadruple differential line receivers.

The SN75174 is characterized for operation from 0°C to 70°C .

**N PACKAGE
(TOP VIEW)**

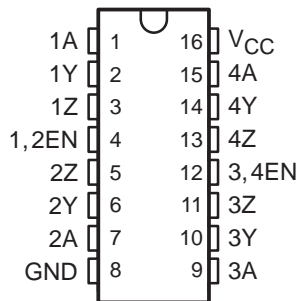

**DW PACKAGE
(TOP VIEW)**

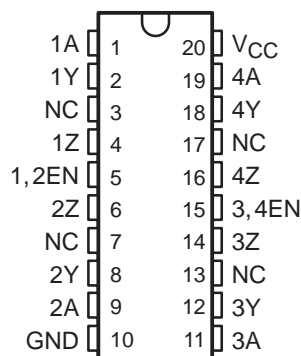

NC – No internal connection

**FUNCTION TABLE
(each driver)**

INPUT	ENABLE	OUTPUTS	
		Y	Z
H	H	H	L
L	H	L	H
X	L	Z	Z

H = TTL high level, X = irrelevant,
L = TTL low level, Z = high impedance (off)



Please be aware that an important notice concerning availability, standard warranty, and use in critical applications of Texas Instruments semiconductor products and disclaimers thereto appears at the end of this data sheet.

PRODUCTION DATA information is current as of publication date. Products conform to specifications per the terms of Texas Instruments standard warranty. Production processing does not necessarily include testing of all parameters.

**TEXAS
INSTRUMENTS**

POST OFFICE BOX 655303 • DALLAS, TEXAS 75265

Copyright © 1995, Texas Instruments Incorporated

SN75174 QUADRUPLE DIFFERENTIAL LINE DRIVER

SLLS039B – OCTOBER 1980 – REVISED MAY 1995

logic symbol†

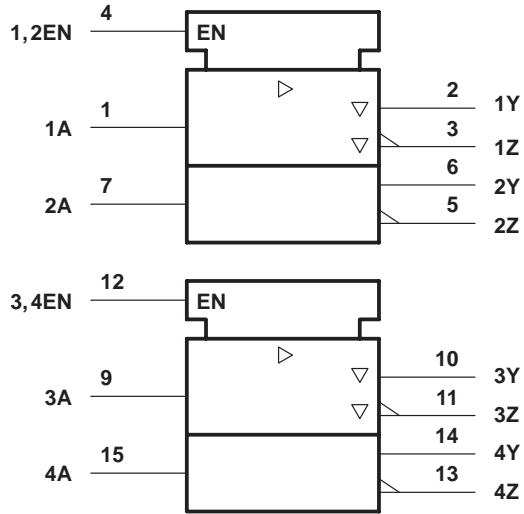

logic diagram, each driver (positive logic)

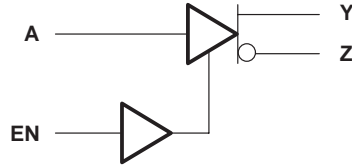

† This symbol is in accordance with ANSI/IEEE Std 91-1984 and IEC Publication 617-12.

schematics of inputs and outputs

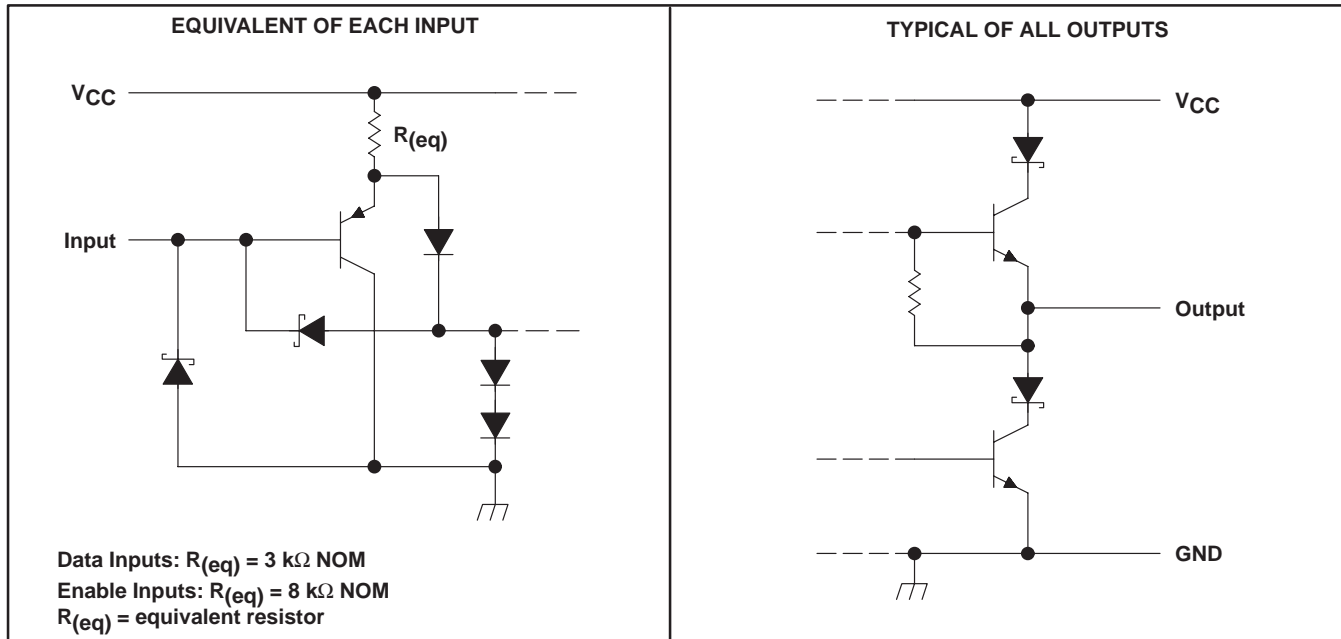

SN75174 QUADRUPLE DIFFERENTIAL LINE DRIVER

SLLS039B – OCTOBER 1980 – REVISED MAY 1995

absolute maximum ratings over operating free-air temperature (unless otherwise noted)†

Supply voltage, V_{CC} (see Note 1)	7 V
Output voltage range, V_O	–10 V to 15 V
Input voltage, V_I	5.5 V
Continuous total dissipation	See Dissipation Rating Table
Operating free-air temperature range, T_A	0°C to 70°C
Storage temperature range, T_{stg}	–65°C to 150°C
Lead temperature 1,6 mm (1/16 inch) from case for 10 seconds	260°C

† Stresses beyond those listed under “absolute maximum ratings” may cause permanent damage to the device. These are stress ratings only, and functional operation of the device at these or any other conditions beyond those indicated under “recommended operating conditions” is not implied. Exposure to absolute-maximum-rated conditions for extended periods may affect device reliability.

NOTE 1: All voltage values are with respect to the network ground terminal.

DISSIPATION RATING TABLE

PACKAGE	$T_A \leq 25^\circ\text{C}$ POWER RATING	DERATING FACTOR ABOVE $T_A = 25^\circ\text{C}$	$T_A = 70^\circ\text{C}$ POWER RATING
DW	1125 mW	9.0 mW/°C	720 mW
N	1150 mW	9.2 mW/°C	736 mW

recommended operating conditions

	MIN	NOM	MAX	UNIT
Supply voltage, V_{CC}	4.75	5	5.25	V
High-level input voltage, V_{IH}	2			V
Low-level input voltage, V_{IL}			0.8	V
Common-mode output voltage, V_{OC}		–7 to 12		V
High-level output current, I_{OH}			–60	mA
Low-level output current, I_{OL}			60	mA
Operating free-air temperature, T_A	0		70	°C



SN75174 QUADRUPLE DIFFERENTIAL LINE DRIVER

SLLS039B – OCTOBER 1980 – REVISED MAY 1995

electrical characteristics over recommended ranges of supply voltage and operating free-air temperature (unless otherwise noted)

PARAMETER		TEST CONDITIONS		MIN	TYP†	MAX	UNIT
V _{IK}	Input clamp voltage	I _I = -18 mA				-1.5	V
V _{OH}	High-level output voltage	V _{IH} = 2 V, I _{OH} = -33 mA	V _{IL} = 0.8 V,		3.7		V
V _{OL}	Low-level output voltage	V _{IH} = 2 V, I _{OL} = 33 mA	V _{IL} = 0.8 V,		1.1		V
V _O	Output voltage	I _O = 0		0		6	V
V _{OD1}	Differential output voltage	I _O = 0		1.5	6	6	V
V _{OD2}	Differential output voltage	R _L = 100 Ω,	See Figure 1	1/2 V _{OD1} or 2‡			V
		R _L = 54 Ω,	See Figure 1	1.5	2.5	5	V
V _{OD3}	Differential output voltage	See Note 2		1.5		5	V
Δ V _{OD}	Change in magnitude of differential output voltage§					±0.2	V
V _{OC}	Common-mode output voltage¶	R _L = 54 Ω or 100 Ω, See Figure 1				+3 -1	V
Δ V _{OC}	Change in magnitude of common-mode output voltage§					±0.2	V
I _O	Output current with power off	V _{CC} = 0, V _O = -7 V to 12 V				±100	μA
I _{OZ}	High-impedance-state output current	V _O = -7 V to 12 V				±100	μA
I _{IH}	High-level input current	V _I = 2.7 V				20	μA
I _{IL}	Low-level input current	V _I = 0.5 V				-360	μA
I _{OS}	Short-circuit output current	V _O = -7 V				-180	mA
		V _O = V _{CC}				180	
		V _O = 12 V				500	
I _{CC}	Supply current (all drivers)	No load	Outputs enabled		38	60	mA
			Outputs disabled		18	40	

† All typical values are at V_{CC} = 5 V and T_A = 25°C.

‡ The minimum V_{OD2} with a 100-Ω load is either 1/2 V_{OD1} or 2 V, whichever is greater.

§ Δ|V_{OD}| and Δ|V_{OC}| are the changes in magnitude of V_{OD} and V_{OC}, respectively, that occur when the input is changed from a high level to a low level.

¶ In ANSI Standard EIA/TIA-422-B, V_{OC}, which is the average of the two output voltages with respect to ground, is called output offset voltage, V_{OS}.

NOTE 2: See EIA Standard RS-485.

switching characteristics, V_{CC} = 5 V, T_A = 25°C

PARAMETER		TEST CONDITIONS		MIN	TYP	MAX	UNIT
t _{d(OD)}	Differential-output delay time	R _L = 54 Ω,	See Figure 2		45	65	ns
t _{t(OD)}	Differential-output transition time				80	120	
t _{pZH}	Output enable time to high level	R _L = 110 Ω,	See Figure 3		80	120	ns
t _{pZL}	Output enable time to low level	R _L = 110 Ω,	See Figure 4		55	80	ns
t _{pHZ}	Output disable time from high level	R _L = 110 Ω,	See Figure 3		75	115	ns
t _{pLZ}	Output disable time from low level	R _L = 110 Ω,	See Figure 3		18	30	ns



SN75174 QUADRUPLE DIFFERENTIAL LINE DRIVER

SLLS039B – OCTOBER 1980 – REVISED MAY 1995

SYMBOL EQUIVALENTS

DATA SHEET PARAMETER	EIA/TIA-422-B	RS-485
V_O	V_{oa}, V_{ob}	V_{oa}, V_{ob}
$ V_{OD1} $	V_o	V_o
$ V_{OD2} $	$V_t (R_L = 100 \Omega)$	$V_t (R_L = 54 \Omega)$
$ V_{OD3} $		V_t (Test Termination Measurement 2)
$\Delta V_{OD} $	$ V_t - \bar{V}_t $	$ V_t - \bar{V}_t $
V_{OC}	$ V_{os} $	$ V_{os} $
$\Delta V_{OC} $	$ V_{os} - \bar{V}_{os} $	$ V_{os} - \bar{V}_{os} $
I_{OS}	$ I_{sa} , I_{sb} $	
I_O	$ I_{xa} , I_{xb} $	I_{ia}, I_{ib}

PARAMETER MEASUREMENT INFORMATION

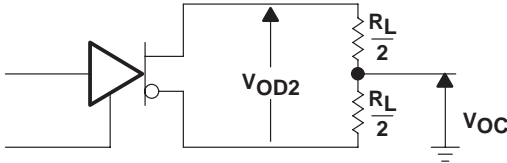
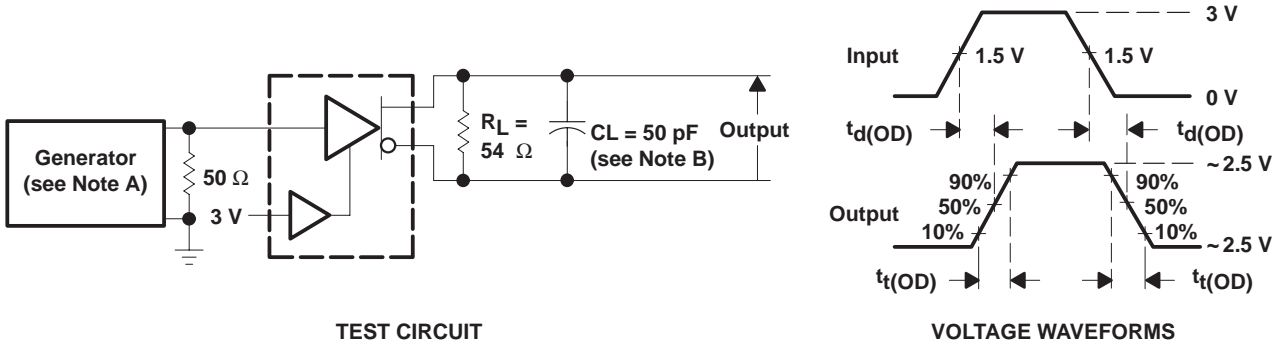

Figure 1. Differential and Common-Mode Output Voltages



- NOTES: A. The input pulse is supplied by a generator having the following characteristics: $t_r \leq 5 \text{ ns}$, $t_f \leq 5 \text{ ns}$, $\text{PRR} \leq 1 \text{ MHz}$, duty cycle = 50%, $Z_O = 50 \Omega$.
 B. C_L includes probe and stray capacitance.

Figure 2. Differential-Output Test Circuit and Voltage Waveforms

SN75174 QUADRUPLE DIFFERENTIAL LINE DRIVER

SLLS039B – OCTOBER 1980 – REVISED MAY 1995

PARAMETER MEASUREMENT INFORMATION

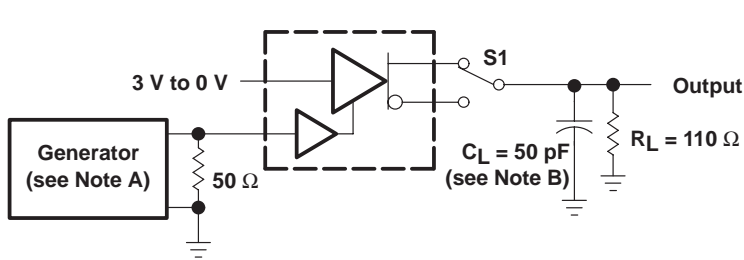

TEST CIRCUIT

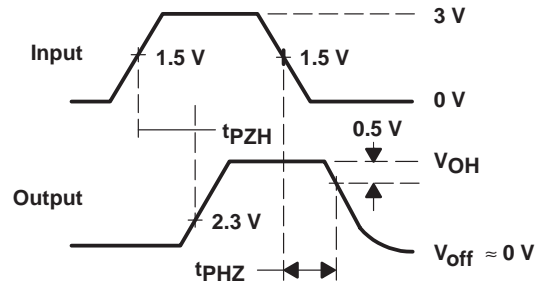

VOLTAGE WAVEFORMS

- NOTES: A. The input pulse is supplied by a generator having the following characteristics: PRR \leq 1 MHz, duty cycle = 50%, $t_r \leq$ 5 ns, $t_f \leq$ 5 ns, $Z_O = 50 \Omega$.
 B. C_L includes probe and stray capacitance.

Figure 3. Test Circuit and Voltage Waveforms

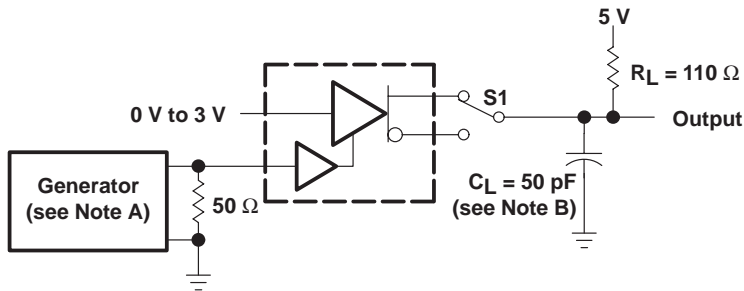

TEST CIRCUIT

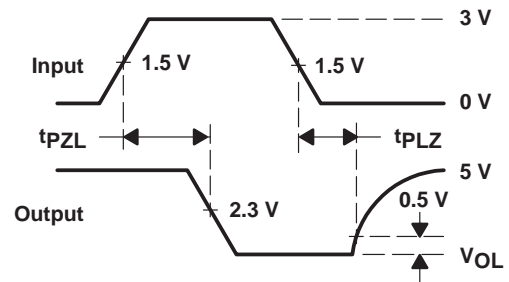

VOLTAGE WAVEFORMS

- NOTES: A. The input pulse is supplied by a generator having the following characteristics: PRR \leq 1 MHz, duty cycle = 50%, $t_r \leq$ 5 ns, $t_f \leq$ 5 ns, $Z_O = 50 \Omega$.
 B. C_L includes probe and stray capacitance.

Figure 4. Test Circuit and Voltage Waveforms

TYPICAL CHARACTERISTICS

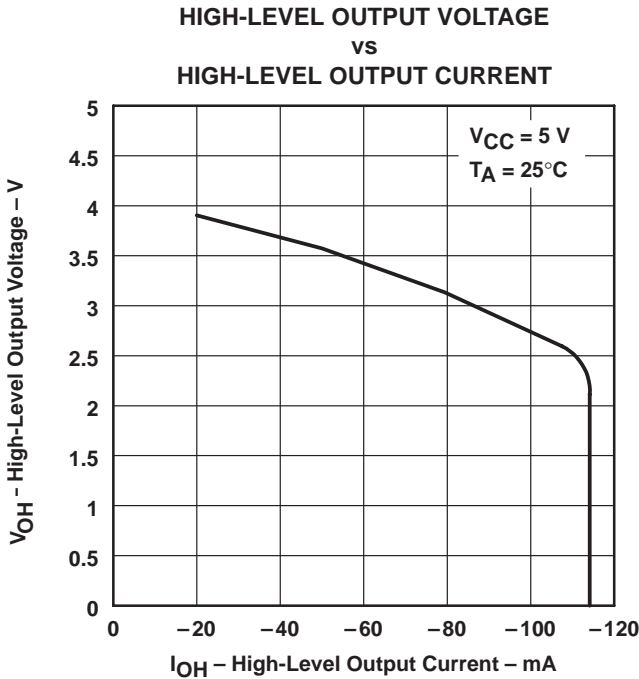

Figure 5

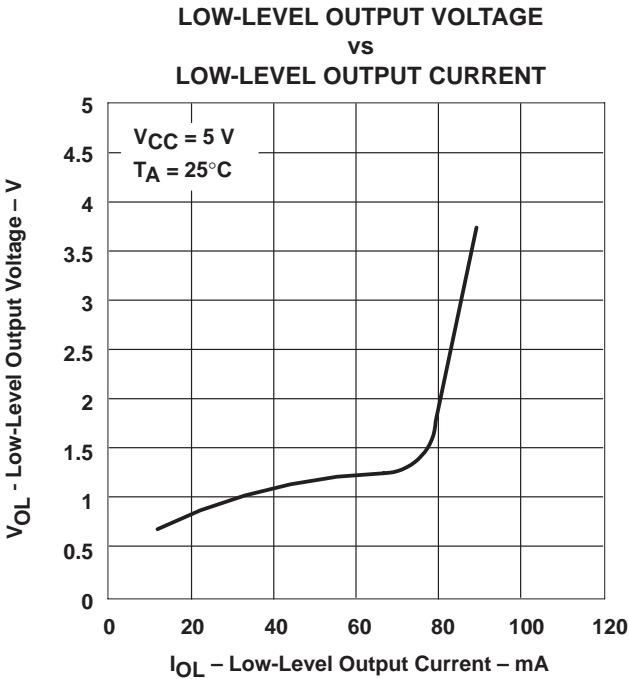

Figure 6

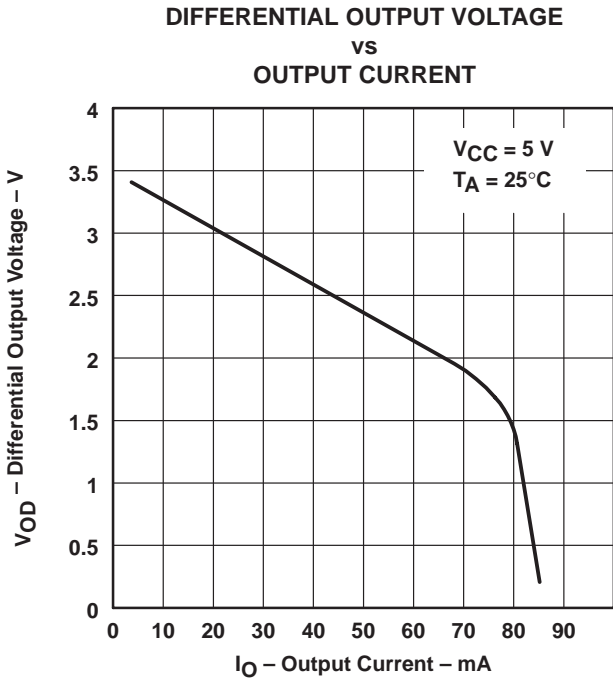

Figure 7

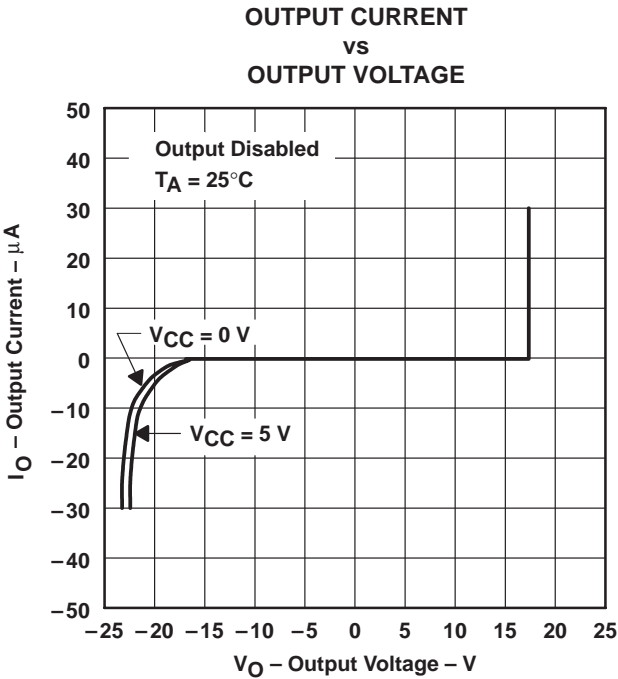

Figure 8

SN75174 QUADRUPLE DIFFERENTIAL LINE DRIVER

SLLS039B – OCTOBER 1980 – REVISED MAY 1995

TYPICAL CHARACTERISTICS

**SUPPLY CURRENT
vs
SUPPLY VOLTAGE**

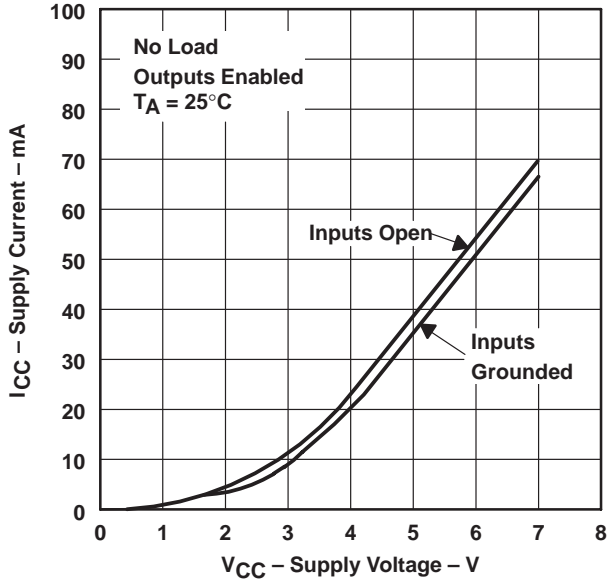

Figure 9

**SUPPLY CURRENT
vs
SUPPLY VOLTAGE**

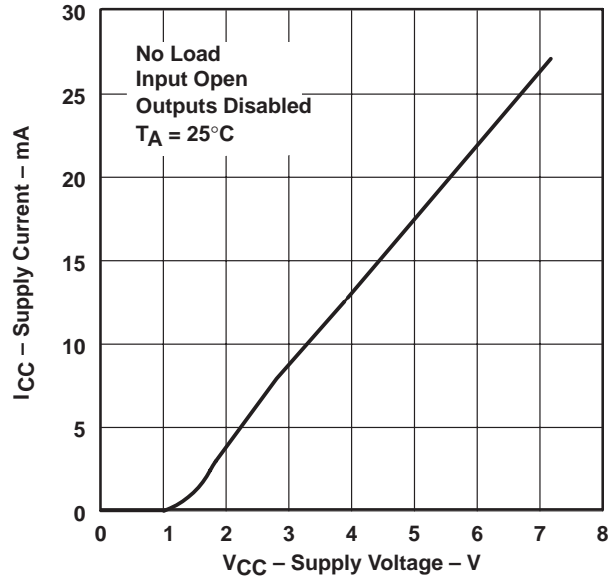
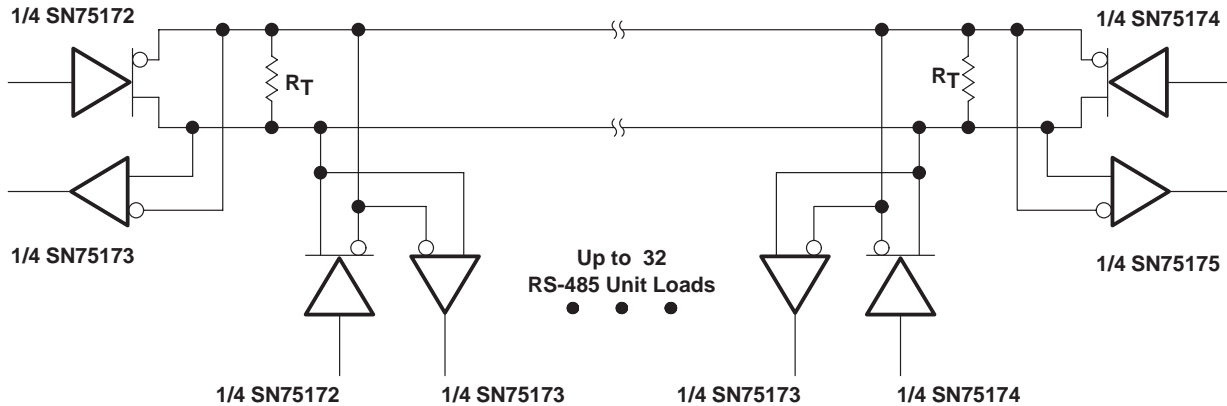

Figure 10

APPLICATION INFORMATION



NOTE: The line length should be terminated at both ends in its characteristic impedance ($R_T = Z_0$). Stub lengths off the main line should be kept as short as possible.

Figure 11. Typical Application Circuit