

# Precision Rotary Potentiometer



# Precision Rotary Potentiometer

with resistance, current or voltage output

## ... Construction

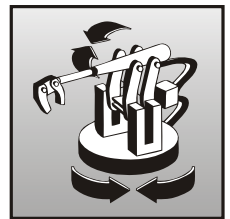
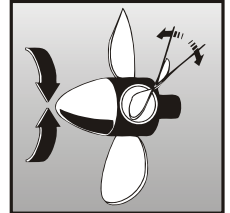
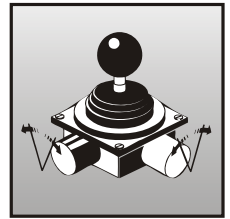
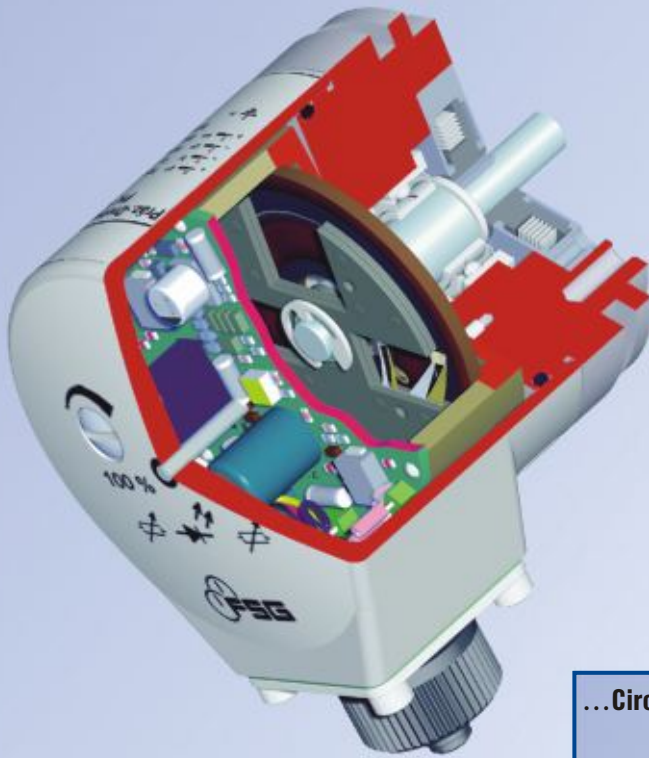

## ... Circuits and characteristic curves

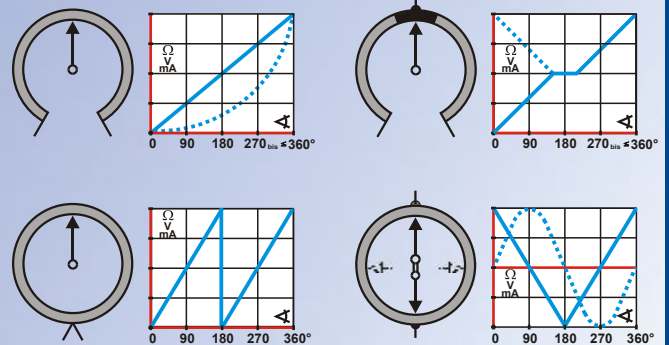

Today potentiometric Angular Position Transmitters attain a still more status with regard to the analogue measuring technique as far as high-quality measurement tasks are concerned due to the favourable value for money.

They are mainly used for

- **Power and braking control elements for railway vehicles as well as ship telegraphs**
- **Rudder and propeller systems for ships**
- **Control drives for systems in the field of energy management and chemical industry**
- **Lifting gears and slewing mechanisms of cranes and excavators**
- **Tail vanes for meteorological measurements**
- **As dancer potentiometers for textile and paper machinery**
- **As well as for measurements in the field of mechanical, apparatus and medical engineering**

Potentiometric transmitters have either a high-resolution element of conductive plastic or a high-resolution gold or constantan wire with various resistance and angle values.

They are available in various sizes as single-turn or multiple-turn potentiometers or in a multiple design.

For adjustment of the measuring range almost all series can be provided with short-circuiting tracks, taps and function windings.

Some models are available with incorporated Signal Converter providing current or voltage outputs in configuration of 2, 3 or 4 wires.



To ensure reliability in very dirty atmospheres, oil-filled potentiometers are available.

Moreover, to provide protection for all potentiometers from mechanical damage, dusty and damp industrial atmospheres a series of casings with a degree of protection IP 40 to IP 68 is available which can be equipped with gearing and limit switches.

# ...Versions and Circuit Variations

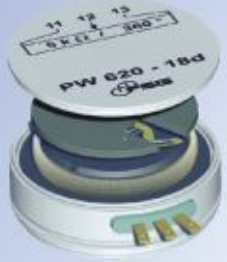
**...series PW**



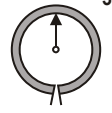
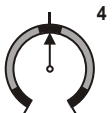
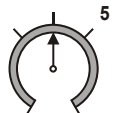
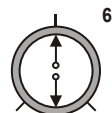
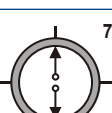
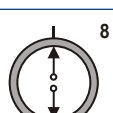
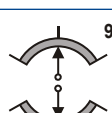



		
		
		

Resistance elements as **ring winding** with wire winding on an anodised anchor ring can be provided with any circuit, angle and resistance values.

1. wiper limited by stops
2. wiper rotatable over 360° with reactive winding
3. wiper rotatable over 360° without reactive winding (sawtooth shape)
4. any arrangement of short circuiting tracks
5. any arrangement of tappings
6. 7. 8. special windings with characteristic curve of the linear or sin./cos. type
9. two electrically isolated windings on a winding former, angle  $\leq 175^\circ$

**...series PW**

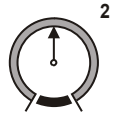

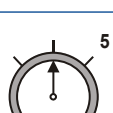



		
		

Resistance elements as **straight winding** with wire winding on a coated former of copper wire are used in potentiometers of the multiple-turn or linear type but also in single-turn potentiometers with active angles up to max. 355°.

1. wiper limited by stops
2. wiper rotatable over 360° only for purposes of putting into operation
4. any arrangement of short circuiting tracks
5. any arrangement of tappings

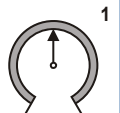
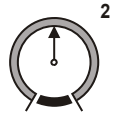
**...series PK**

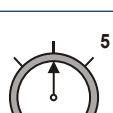

		
		

Resistance elements of **conductive plastic**, imprinted on glass-fiber reinforced support material. The max. active angle amounts to 355°. Smaller angles, tappings and short circuiting tracks on request.

1. wiper limited by stops
2. wiper rotatable over 360°
4. any arrangement of short circuiting tracks
5. any arrangement of tappings
9. two electrically isolated windings on a winding former, angle  $\leq 175^\circ$

**...series PK/PW...-MU**

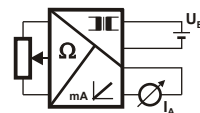
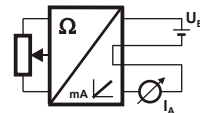
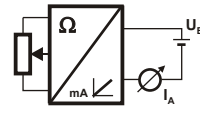

	4 wires galvanically isolated
	3 or 4 wires
	2 wires

**Angular Position Transducers**, equipped with resistance elements of wire or plastic with integrated R/I or R/V Converter for a current or voltage signal output, optional with a configuration of 2, 3 or 4 wires.

Also available with galvanic isolation between supply and output signal as far as version with 4 wires is concerned.

All types of transducers are provided with back trimmers matching the output signal within wide limits to the respective angular position.

# ...Electrical Specifications

Series	PW 45	PW 70 <sup>1)</sup>	PW 613	PW 620	PW 1023
Max. active angle	360°	360°	360°	360°	360°
Stops at max.	345°	350°	345°	345°	345°
Resistance on angle limited by stops	min. 25 Ω max. 20 kΩ	min. 50 Ω max. 50 kΩ	min. 25 Ω max. 20 kΩ	min. 25 Ω max. 20 kΩ	min. 25 Ω max. 20 kΩ
Resistance tolerance <sup>2)</sup>	± 5 %	± 5 %	± 5 %	± 5 %	± 5 %
Linearity tolerance <sup>2)</sup>	± 0,3 up to 0,2 %	± 0,2 up to 0,15 %	± 0,3 up to 0,2 %	± 0,3 up to 0,2 %	± 0,3 up to 0,2 %
Resolution	0,5 up to <0,1 %	0,3 up to <0,1 %	0,5 up to <0,1 %	0,5 up to <0,1 %	0,5 up to <0,1 %
Capacity	2,5 W	6 W	2,5 W	2,5 W	2,5 W
Multiple design	twofold	sixfold	sixfold	sixfold	--
Functional winding	•	•	•	•	•
Oilfilling	•	•	•	•	--
Limit switches	--	version M... only	•	•	--
Temperature coefficient	17 ppm				

<sup>1)</sup> also available with integrated slipping clutch    <sup>2)</sup> constricted resistance and linearity tolerances possible

Series	PW 609/611	PW 613/620	PW 0045	PW 55	PW45W3/W10 <sup>3)</sup>
Max. active angle	340°	345°	280°..345°	345°	W3   1080° W10   3600°
Stops at max.	340°	345°	280°..345°	345°	W3   1080° W10   3600°
Resistance on angle limited by stops	min. 25 Ω max. 20 kΩ	min. 25 Ω max. 50 kΩ	min. 25 Ω max. 50 kΩ	min. 25 Ω max. 50 kΩ	min. 25 Ω max. 50 kΩ
Resistance tolerance	± 5 %	± 5 %	± 5 %	± 5 %	± 5 %
Linearity tolerance	± 0,5 %	± 0,2 %	± 0,5 %	± 0,5 %	± 0,1 %
Resolution	± 0,5 %	± 0,2 %	± 0,2 %	± 0,2 %	0,1 up to 0,01 %
Capacity	0,5 W	1 W	1,5 W	1,5 W	2 W
Multiple design	threefold	sixfold	--	stackable	--
Temperature coefficient	17 ppm				

<sup>3)</sup> PW45W3 and PW45W10 are multi-turn potentiometers for 3 or 10 turns

Series	PK 609	PK 611	PK 613	PK 620	PK 1023
Max. active angle ± 2°	340°	347°	352°	355°	355°
Stops at max. ± 2°	340°	345°	345°	345°	not limited by stops
Resistance	1, 2 or 5 kΩ	1, 2 or 5 kΩ	1, 2 or 5 kΩ	1, 2 or 5 kΩ	1, 2 or 5 kΩ
Resistance tolerance	± 20 %	± 20 %	± 10 %	± 10 %	± 10 %
Linearity tolerance <sup>4)</sup>	± 0,5 %	± 0,5 %	± 0,2 %	± 0,1 %	± 0,1 %
Resolution	∞	∞	∞	∞	∞
Capacity	0,5 W	0,5 W	1 W	1 W	1 W
Multiple design	threefold	threefold	sixfold	sixfold	twofold
Temperature coefficient	200 ppm				

<sup>4)</sup> favourably priced version with ± 1 - 2 % available

Series	PW/PK613-MU	PW/PK620-MU	PW/PK1023-MU
Voltage output	--	0-10 and 2-10 V respec.	
Load resistance		≥ 500 Ω	
Current output		0-20 and 4-20 mA respec.	
Load resistance		≤ 600 Ω	
Supply voltage		18-33 V DC	
Current consumption		approx. 80 mA	
4 wires galvanically isolated	--	•	•
2, 3 or 4 wires	•	•	•
Temperature coefficient	max. 1 ‰ / 10K, typically: 0,5 ‰ / 10K		
Linearity	± 0,2 %	± 0,1 %	± 0,1 %

General data	
Temperature coefficient	-30 up to +70 °C
Testing voltage	550 V, 50 Hz, 1 min.
EMC test according to	DIN 50 081-1 Generic Emission Standard DIN 50 082-2 Generic Immunity Standard

zero point and steepness to be matched via trimmer

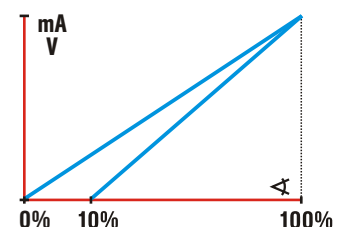
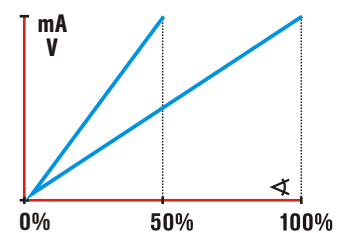

# ...Models

**PW70**

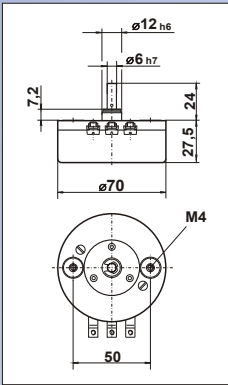

**PW45**

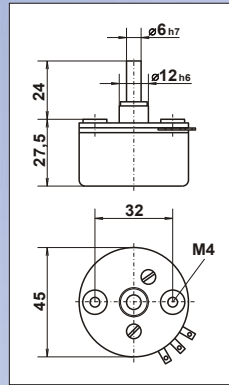

**PK/PW613/620**

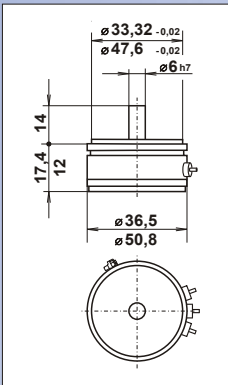

**PK/PW609/611**

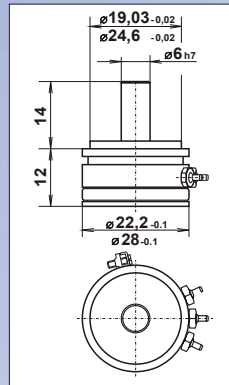

**PW0045**

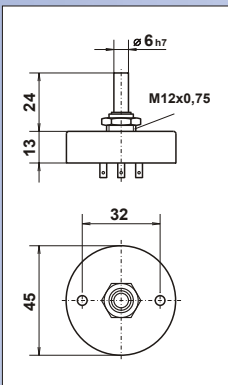

**PW55**

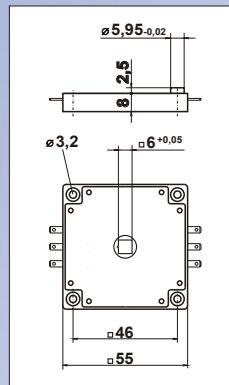

**PW70M...**

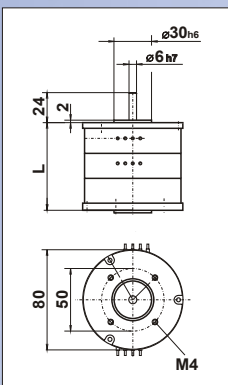

<b>L</b>	50	70	90	110	130	150
	MI	MII	MIII	MIV	MV	MVI

**PW45W10**

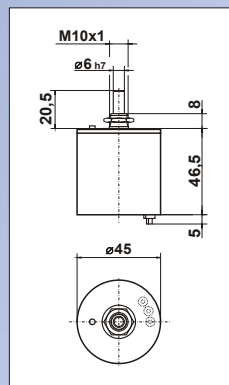



# ...Models

## PW/PK613-MU/620-MU

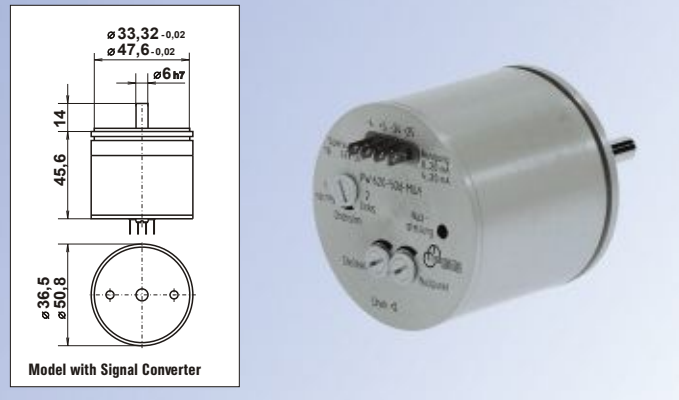

## PW/PK1023

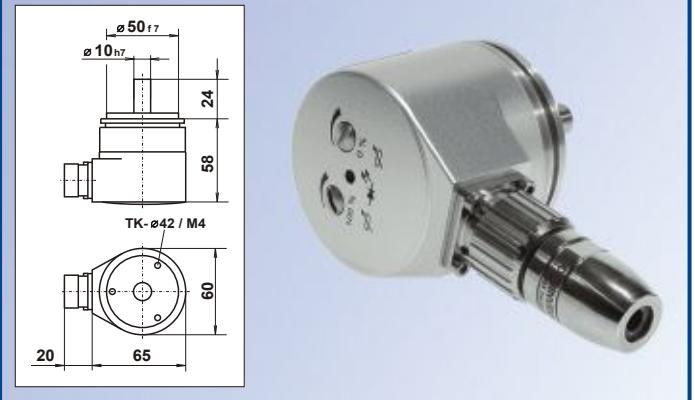

### ... mechanical characteristics of FSG models

Series	PW 0045	PW 45 PW 70	PW 55	PW45W3 PW45W10
Casing material	thermoplastic	PW45 thermoplastic PW70 thermoset	thermoplastic	brass coated thermoplastic
Shaft bearing	sintered bearing	ball - or sintered bearing	plastic friction bearing	sintered bearing
Shaft material	stainless steel			
Connection	solder-type terminals	solder-type terminals or screw connection	plug Faston	solder-type terminals
IP code of casing	IP 30			
Torque (single version only)	PW 0045m 0,5 Ncm PW 0045h 5 Ncm	PW45 0,3 or 3 Ncm PW70 0,5 Ncm	0,2 Ncm	0,5 Ncm
Torque (oilfilling)	--	1 Ncm	--	--
Weight for single version only	70 g	PW45 70 g PW 70 140 g	50 g	PW45W3 100 g PW45W10 150 g
Fastening	central thread	threaded hole	through hole	central thread

### ... mechanical characteristics of servo mount models

Series	PW/PK 609	PW/PK 611	PW/PK 613	PW/PK 620	PW/PK 1023
Casing material	Alu, black anodised				Alu, cover coated
Shaft bearing	ball or sintered bearing				ball bearing
Shaft material	stainless steel				
Connection	Faston- or stranded wires				plug or cable
IP code of casing	IP 30				IP 65
Torque	0,03 Ncm	0,04 Ncm	0,05 Ncm	0,05 Ncm	2,5 Ncm
Torque (oilfilling)	--	--	1,0 Ncm	1,0 Ncm	--
Weight for single version only	15 g	20 g	40 g	70 g	370 g
Weight with transducer	--	--	65 g	120 g	400 g
Fastening	clamp or central thread or threaded holes				clamp or threaded hole

### General data

Resistance to vibration	5 - 200 Hz, 10 g
Shock resistance	50 g, 6 ms
Lifetime	high life by using a patented helical wiper 10 - 100 Mio.