

IXR100

Isolated, Self-Powered, Temperature Sensor Conditioning 4-20mA TWO-WIRE TRANSMITTER

FEATURES

- 1500Vrms ISOLATION
- TRUE TWO-WIRE OPERATION :
Power and Signal on One Wire Pair
- RESISTANCE OR VOLTAGE INPUT
- DUAL MATCHED CURRENT SOURCES:
400 μ A at 7V
- WIDE SUPPLY RANGE 12V TO 36V
- PT100 RTD LINEARIZATION

DESCRIPTION

The IXR100 is an isolated 2-wire transmitter featuring loop powered operation and resistive temperature sensor conditioning (excitation and linearization). It contains a DC/DC convertor, high accuracy instrumentation amplifier with single resistor programmable span and linearization, and dual matched excitation current sources. This combination is ideally suited to a range of transducers such as thermocouples, RTDs, thermistors and strain gages. The small size makes it ideal for use in head mounted isolated temperature transmitters as well as rack and rail mounted equipment.

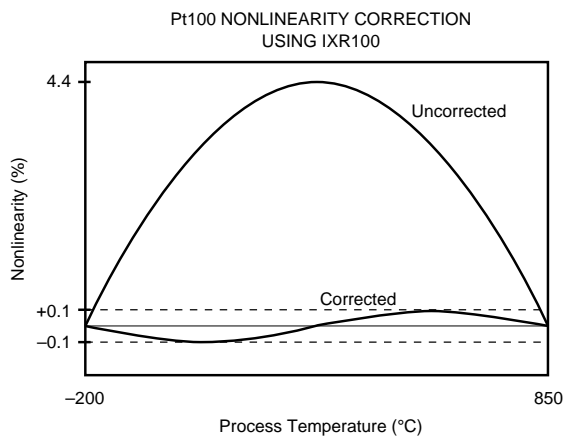

APPLICATIONS

- INDUSTRIAL PROCESS CONTROL:
All Types of Isolated Transmitters;
Pt100 RTD
Thermocouple Inputs
Current Shunt (mV) Inputs
- ISOLATED DUAL CURRENT SOURCES
- AUTOMATED MANUFACTURING
- POWER PLANT/ENERGY MONITORING
- GROUND LOOP ELIMINATION

The isolated two-wire transmitter allows signal transmission and device power to be supplied on a single wire-pair by modulating the power supply current with the isolated signal source. The transmitter is resistant to voltage drops from long runs and noise from motors, relays, actuators, switches, transformers and industrial equipment.

It can be used by OEMs producing isolated transmitter modules or by data acquisition system manufacturers. The IXR100 is also useful for general purpose isolated current transmission where the elimination of ground loops is important.

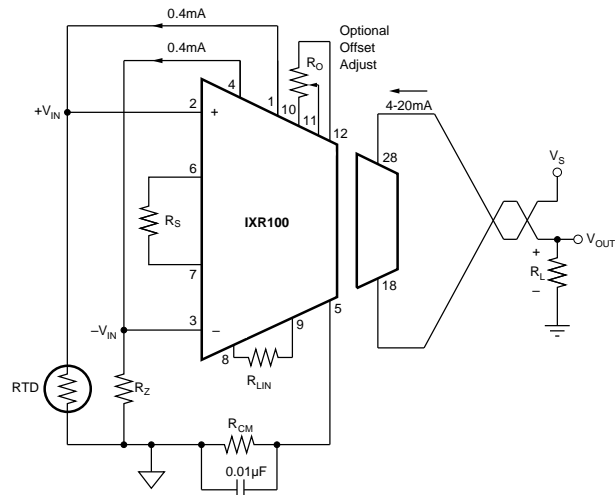

International Airport Industrial Park • Mailing Address: PO Box 11400 • Tucson, AZ 85734 • Street Address: 6730 S. Tucson Blvd. • Tucson, AZ 85706
Tel: (520) 746-1111 • Twx: 910-952-1111 • Cable: BBRCORP • Telex: 066-6491 • FAX: (520) 889-1510 • Immediate Product Info: (800) 548-6132

SPECIFICATIONS

ELECTRICAL

At $V_S = +24V$, $T_A = +25^\circ C$, unless otherwise noted.

PARAMETER	CONDITIONS	IXR100			UNITS
		MIN	TYP	MAX	
OUTPUT AND LOAD CHARACTERISTICS					
Output Current	Linear Operating Region	4	32	20	mA
Output Current Limit		11.6		36	mA
Loop Supply Voltage					VDC
Load Resistance		$R_{LOAD} = (V_S - 11.6)/I_O$			Ω
ZERO					
Initial Error ⁽¹⁾ vs Temperature	$V_{IN} = 0, R_S = \infty$			300 200	μA ppm FSR/ $^\circ C$
SPAN					
Output Current Equation	R_S in Ω , V_{IN} in V	$I_O = 4mA + [0.016 + (40/R_S)] (V_{IN})$			A/V
Span Equation		$S = [0.016 + (40/R_S)]$			
Untrimmed Error vs Temperature	(1) Excluding TCR of R_S	-2.5	50	0 100	% ppm/ $^\circ C$
Nonlinearity : EMF Input	(2)		0.01	0.025	%FSR
: Pt100 Input	(3)		0.1		%FSR
INPUT					
Voltage Range	$R_S = \infty$ V_{IN+}, V_{IN-} with Respect to COM		1		V
Common-Mode Range		2		4	V
Offset Voltage			0.5	2.5	mV
vs Temperature			3	5	$\mu V/^\circ C$
vs Supply			100	dB	
CURRENT SOURCES					
Magnitude			0.4		mA
Accuracy				1	%
vs Temperature			50	100	ppm/ $^\circ C$
Match				0.5	%
vs Temperature			25	50	ppm/ $^\circ C$
DYNAMIC RESPONSE					
Settling Time	To 0.1% of Span		500		ms
TEMPERATURE RANGE					
Operating		-20		+70	$^\circ C$
Storage		-40		+85	$^\circ C$
ISOLATION					
Isolation Voltage	V_{ISO} V_{ISO}	1000 JP 1500 KP			V_{rms} V_{rms}

NOTES: (1) Can be adjusted to zero. (2) End point span non-linearity. (3) End point, corrected span non-linearity with a Pt100 RTD input operated from $-200^\circ C$ to $+850^\circ C$.

ABSOLUTE MAXIMUM RATINGS

Power Supply (+ V_S - I_{OUT})	40V
Input Voltage (Com to V_{IN})	9V
Storage Temperature Range	$-40^\circ C$ to $+85^\circ C$
Lead Temperature (soldering 10s)	$+300^\circ C$
Output Current Limit Duration	Continuous
Power Dissipation	500mW



ELECTROSTATIC DISCHARGE SENSITIVITY

Electrostatic discharge can cause damage ranging from performance degradation to complete device failure. Burr-Brown Corporation recommends that this integrated circuit be handled and stored using appropriate ESD protection methods.

PACKAGE INFORMATION

MODEL	PACKAGE	PACKAGE DRAWING NUMBER ⁽¹⁾
IXR100	2-wire Transmitter	901

NOTE: (1) For detailed drawing and dimension table, please see end of data sheet, or Appendix D of Burr-Brown IC Data Book.

The information provided herein is believed to be reliable; however, BURR-BROWN assumes no responsibility for inaccuracies or omissions. BURR-BROWN assumes no responsibility for the use of this information, and all use of such information shall be entirely at the user's own risk. Prices and specifications are subject to change without notice. No patent rights or licenses to any of the circuits described herein are implied or granted to any third party. BURR-BROWN does not authorize or warrant any BURR-BROWN product for use in life support devices and/or systems.

PIN CONFIGURATION

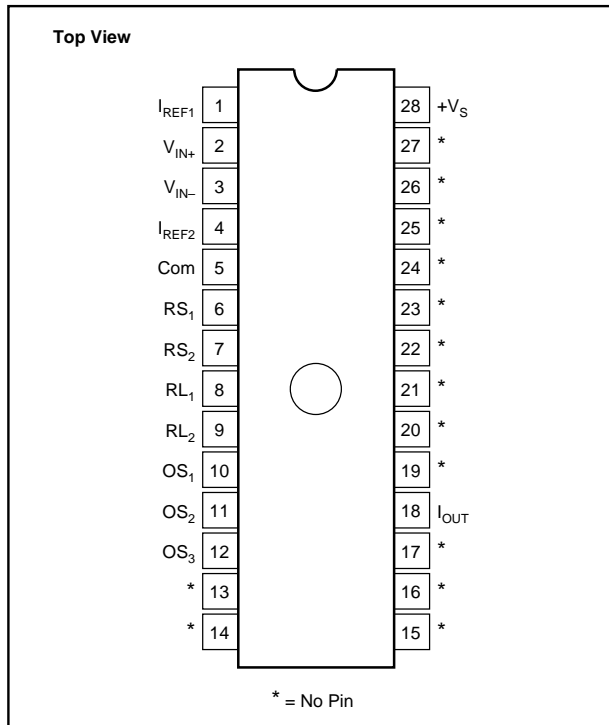

DISCUSSION OF PERFORMANCE

The IXR100 makes the design of isolated two wire 4 to 20mA transmitters easy and provides exceptional performance at very low cost. It combines several unique features not previously available in a single package. These include galvanic isolation, sensor excitation and linearization, excellent DC performance, and low zero and span drift. The IXR100 functions with voltages as low as 11.6V at the device. This allows operation with power supplies at or below 15V. When used with the RCV420 the complete 4 to 20mA current loop requires only 13.1V. If series diode protection is desired the minimum loop supply voltage is still only about 13.7V. This is especially useful in systems where the available supplies are only 15V.

BASIC CONNECTION

The basic connection of the IXR100 is shown in Figure 1. A differential voltage applied between pins 2 and 3 will cause a current of 4 to 20mA to circulate in the two wire output loop pins 28 and 18. Pins 1 and 4 supply the current excitation for resistive sensors. Pins 6 and 7 are provided for the connection of an external span resistor which increases the gain. Pins 8 and 9 provide linearity correction. Pins 10, 11 and 12 adjust the output offset current.

FUNCTIONAL DESCRIPTION

The IXR100 comprises of several functions:

- Sensor excitation
- Internal voltage regulator
- Input amplifier and V/I converter
- Linearization circuit
- DC/DC Converter

SENSOR EXCITATION

Sensor Excitation consists of two matched 0.4mA current sources. One is used to excite the resistive sensor and the other is used to excite the zero balance resistor R_Z . When the linearity correction feature is used these current sources are modulated together so that three wire operation of a Pt100 RTD is possible.

INTERNAL VOLTAGE REGULATOR

The circuitry within the IXR100 regulates the supply voltage to the DC/DC Converter, Input Amplifier, Linearization Amplifier and V/I Converter and removes the normal variations in V_S from these stages as the output spans from 4 to 20mA.

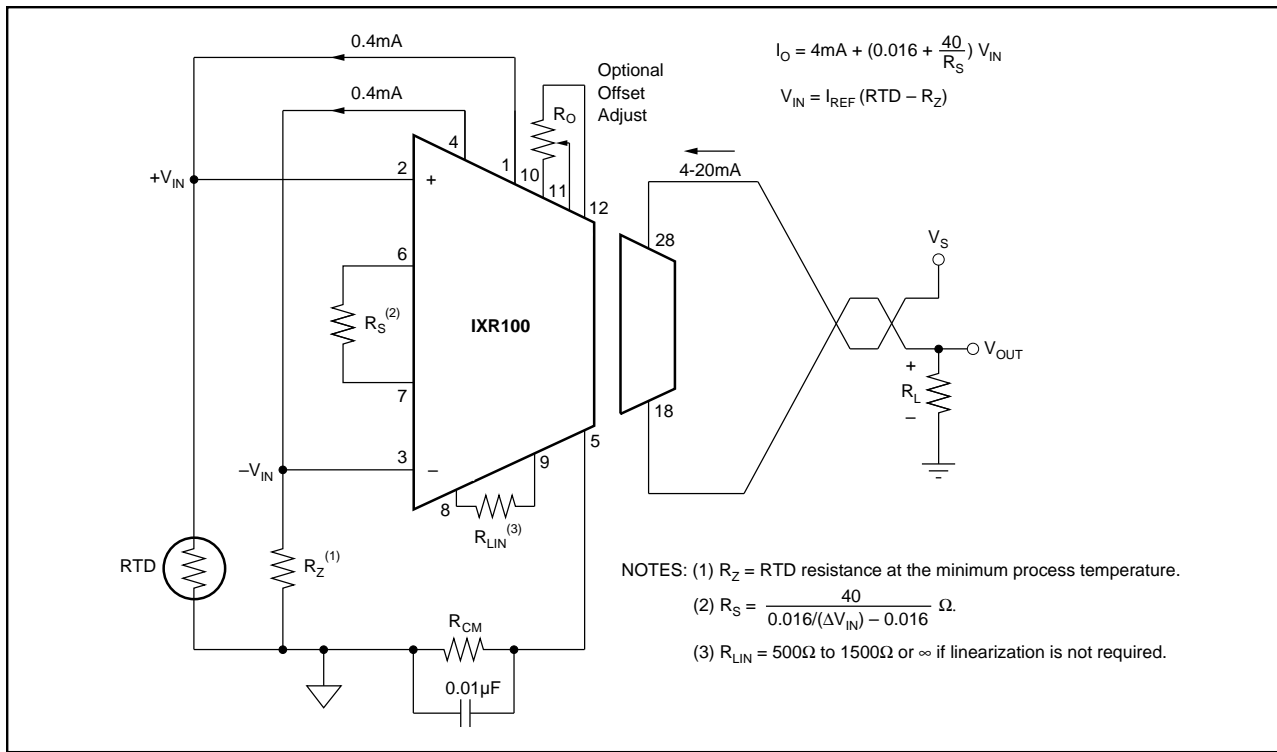

FIGURE 1. Basic Connection for RTD.

INPUT AMPLIFIER AND V/I CONVERTER

The Input Amplifier is an instrumentation amplifier whose gain is set by R_S , it drives the V/I Converter to produce a 4 to 20mA output current. The Input Amplifier has a common mode voltage range of 2 to 4V with respect to COM (pin 5). Normally this requirement is satisfied by returning the currents from the RTD and zero balance resistor R_Z to COM through a common mode resistor R_{CM} . For most applications a single value of 3.9k Ω may be used. When used with RTDs having large values of resistance R_{CM} must be chosen so that the inputs of the amplifier remain within its rated common mode range. R_{CM} should be bypassed with a 0.01 μ F or larger capacitor.

LINEARIZATION CIRCUIT

The Linearity Correction Circuit is unique in several ways. A single external resistor will provide up to 50 times improvement in the basic RTD linearity. Terminal based non-linearity can be reduced to less than $\pm 0.1\%$ for all RTD temperature spans. The Linearization circuit also contains an instrumentation amplifier internally connected to the $\pm V_{IN}$ pins. The gain of this stage is set by R_{LIN} . The output controls the excitation current sources to produce an increasing excitation current as V_{IN} increases. An important feature is that the Linearity Correction is made directly to the RTD output independent of the gain of the Input Amplifier. This provides minimal interaction between R_S and R_Z . This feature can be useful at the systems level by reducing data acquisition system processor overhead previously used to linearize sensor response in software/firmware.

DC/DC CONVERTER

The DC/DC Converter transfers power from the 2 wire current loop across the barrier to the circuitry used on the input side of the isolation barrier.

PIN DESCRIPTIONS

I_{REF1} , I_{REF2}

These pins provide a matched pair of current sources for sensor excitation. These current sources provide excellent thermal tracking, and when the linearization feature is used, are modulated by an equal amount. Their nominal current value is 0.4mA and their compliance voltage is:

$$V_{IN+} < V_{IREF} < (Com + 7V)$$

$$I_{REF} = 400\mu A + \frac{V_{REF}}{2R_{LIN}}$$

$+V_{IN}$, $-V_{IN}$

These are the inputs to both the input amplifier and the linearization amplifier. Because the IXR100 has been optimized for RTD applications, the two sets of inputs are internally connected.

R_{S1} , R_{S2}

The resistor connected across these terminals determines the gain of the IXR100. For normal 4-20mA outputs:

$$R_S = \frac{40}{0.016/(\Delta V_{IN}) - 0.016} \Omega \quad (1)$$

R_{L1}, R_{L2}

The resistor connected between these terminals determines the gain of the linearization circuit and the amount of correction applied to the RTD. Its value may be determined in several ways. Two of which are shown as follows.

1. Empirically by interactively adjusting R_{LIN}, R_S and R_Z to achieve best fit 4 to 20mA output. R_Z is used to set 4mA at minimum input, R_S is adjusted for 12mA with a half span input, and R_{LIN} is adjusted to give 20mA with a full span input. This may require a few iterations but is probably the most practical method for field calibration. R_{LIN} will range between 500Ω and 1500Ω for 100Ω sensors (Pt100, D100, SAMA). Initially it may seem a little strange adjusting R_S for 12mA and R_{LIN} for 20mA. However, convergence is achieved much more quickly as the linearized curve passes through zero and has less effect at the mid span and the linearity trim resistor tends to adjust the transfer function more at the full span than the mid point.
2. Using Table I and linear interpolation for values of span not given in the table. This will yield very accurate results for the Pt100 sensor and acceptable results for D100 and SAMA sensors.

ZERO ADJUST (OPTIONAL) O_{S1}, O_{S2}, O_{S3}

The IXR100 has provision for adjusting the output offset current as shown in Figure 2. In many applications the already low offset will not need to be known at all. This trim effects the V/I converter stage and does not introduce V_{OS} drift errors that occur when the trim is performed at the input stage. If possible use R_Z to trim sensor output error to zero and use the offset control to trim the output to 4mA when V_{IN} = 0V. The offset adjustment can be made with a

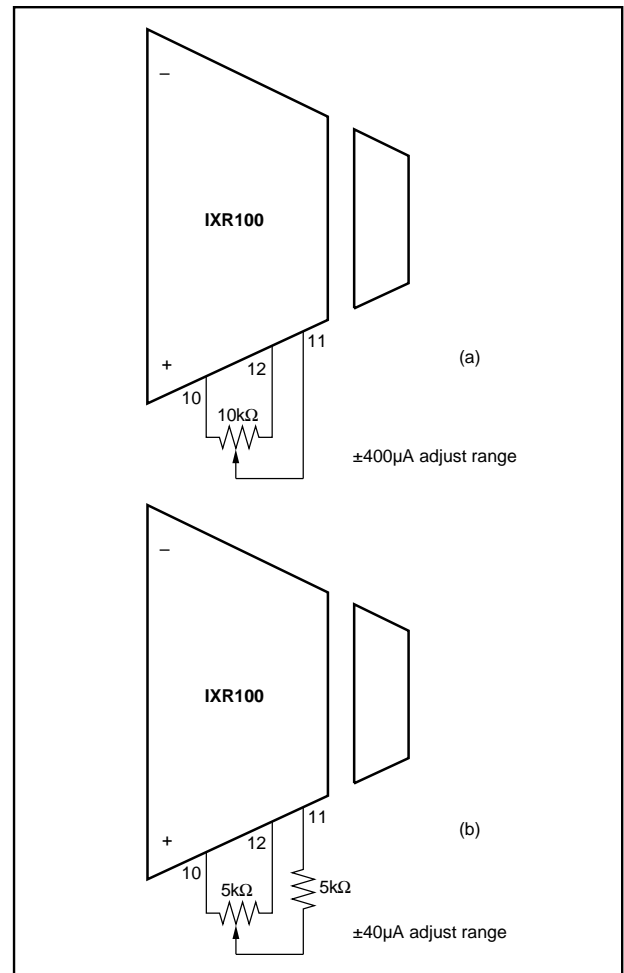

FIGURE 2. Basic Connection for Zero Adjust.

		SPAN ΔT (°C)									
T _{MIN} (°C)	50	100	200	300	400	500	600	700	800	900	1000
-200	573	653	839	995	1083	1131	1152	1159	1159	1154	1140
-150	745	855	1059	1158	1197	1206	1205	1196	1175	1151	1127
-100	983	1105	1228	1251	1249	1231	1207	1182	1156	1129	
-50	1233	1284	1286	1262	1236	1208	1180	1152	1125	1097	
0	1302	1287	1273	1229	1201	1173	1145	1117	1089		
50	1263	1249	1220	1192	1164	1136	1108	1081	1054		
100	1225	1211	1183	1155	1127	1100	1073	1046			
150	1188	1174	1146	1119	1091	1064	1038	1011			
200	1151	1137	1110	1083	1056	1030	1003				
250	1114	1101	1074	1048	1021	995	969				
300	1079	1066	1039	1013	987	962					
350	1044	1031	1005	979	954	928					
400	1009	996	971	946	921						
450	975	963	938	913	888						
500	942	930	905	881							
550	909	897	873	849							
600	877	865	841								
650	845	834	810								
700	814	803									
750	784	773									
800	754										

NOTES: (1) Linear interpolation between two horizontal or vertical values yields acceptable values. (2) Although not optimum, these values will also yield acceptable results with D100 and SAMA 100Ω nominal sensors. (3) Double R_{LIN} value for PT200.

TABLE I. R_{LIN} Values for Pt100 Sensor.

potentiometer connected as shown in Figures 2a and 2b. The circuit shown in Figure 2a provides more range while the circuit in Figure 2b provides better resolution. Note, it is not recommended to use this adjusting procedure for zero elevation or suppression. See the signal suppression and elevation section for the proper techniques.

COM

This is the return for the two excitation currents I_{REF1} and I_{REF2} and is the reference point for the inputs.

V_S , I_{OUT}

These are the connections for the current loop V_S being the most positive connection. For correct operation these pins should have 11.6 to 36V between them.

HIGH VOLTAGE TESTING

Burr-Brown Corporation has adopted a partial discharge test criterion that conforms to the German VDE0884 Optocoupler Standards. This method requires the measurement of minute current pulses ($< 5pC$) while applying 2400rms, 60Hz high-voltage stress across every devices isolation barrier. No partial discharge may be initiated to pass this test. This criterion confirms transient overvoltage ($1.6 \times V_{RATED}$) protection without damage. Life-test results verify the absence of failure under continuous rated voltage and maximum temperature.

This new test method represents the “state-of-the-art” for nondestructive high voltage reliability testing. It is based on

the effects of non-uniform fields existing in heterogeneous dielectric material during barrier degradation. In the case of void non-uniformities, electric field stress begins to ionize the void region before bridging the entire high voltage barrier.

The transient conduction of charge during and after the ionization can be detected externally as a burst of $0.01\mu s$ - $0.1\mu s$ current pulses that repeat on each AC voltage cycle. The minimum AC barrier voltage that initiates partial discharge is defined as the “inception voltage”. Decreasing the barrier voltage to a lower level is required before partial discharge ceases and is defined as the “extinction voltage”.

We have designed and characterized the package to yield an inception voltage in excess of 2400Vrms so that transient overvoltages below this level will not cause any damage. The extinction voltage is above 1500Vrms so that even overvoltage-induced partial discharge will cease once the barrier voltage is reduced to the rated level. Older high voltage test methods relied on applying a large enough overvoltage (above rating) to catastrophically break down marginal parts, but not so high as to damage good ones. Our new partial discharge testing gives us more confidence in barrier reliability than breakdown/no breakdown criteria.

APPLYING THE IXR100

The IXR100 has been designed primarily to correct nonlinearities inherent in RTD sensors. It may also be used in other applications where its excellent performance makes it superior to other devices available. Examples are shown in the Applications Section.

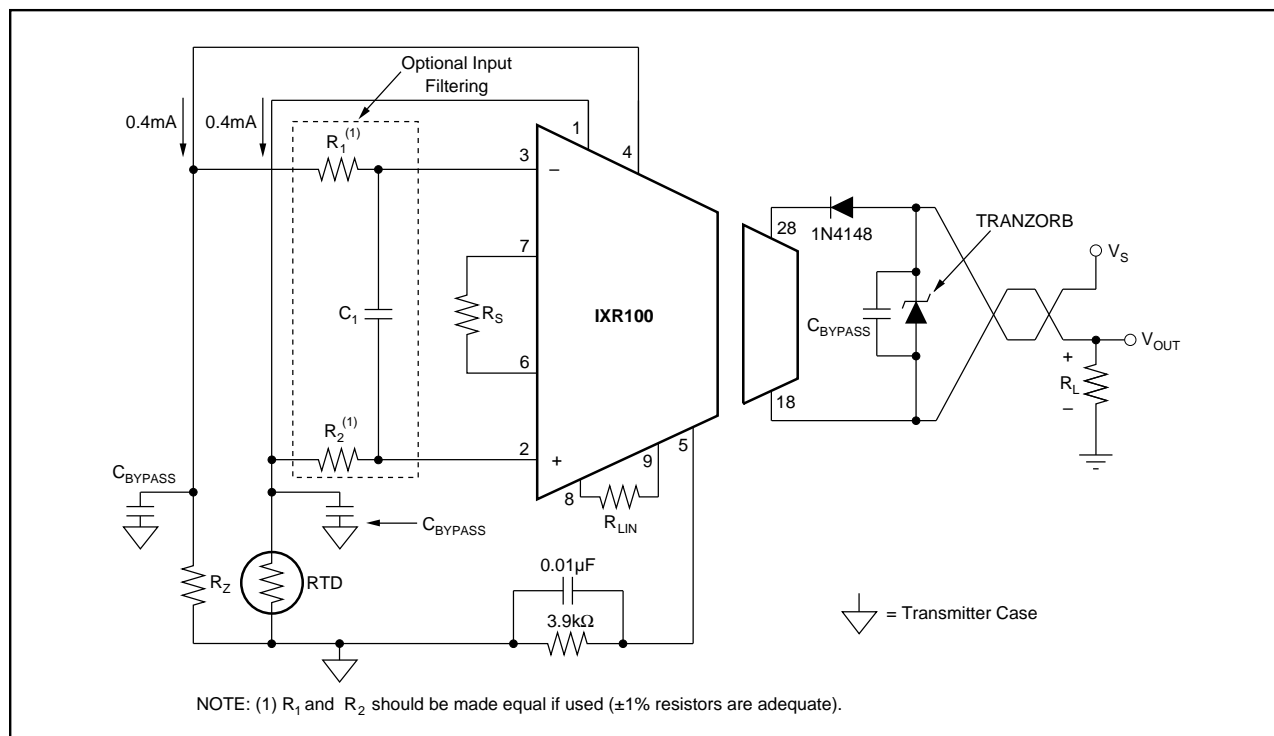

FIGURE 3. Transient and RFI Protection Circuit.

RFI AND TRANSIENT SUPPRESSION

Radio frequency interference and transients are a common occurrence in 4-20mA loops, especially when long wiring lengths are involved. RFI usually appears as a temporary change in output and results from rectification of the radio signal by one or more stages in the amplifier. For sensors which are closely coupled to the IXR100 and are contained in a common metal housing, the usual entry for RFI is via the 4-20mA loop wiring. Coaxial bypass capacitors may be used with great effectiveness to bring these leads into the transducer housing while suppressing the RFI. Values of 100 to 1000pF are generally recommended. For sensors remote from the IXR100, coaxial capacitors can also be used to filter the excitation and signal leads. Additional low-pass filtering at the IXR100 input helps suppress RFI. The easiest way to do this is with the optional differential RC filter shown in Figure 4. Typical values for R_1 and R_2 are 100-1000 Ω , and for C_1 are 100-1000pF.

Transient suppression for negative voltages can be provided by the reverse-polarity protection diodes discussed later. However, positive transients cannot be handled by these diodes and do frequently occur in field-mounted loops. A shunt zener diode is of some help, but most zener diodes suffer from limited current-handling capacity and slow turn-on. Both of these characteristics can lead to device failure before the zener conducts. One type of zener, called the TRANZORB and available from General Semiconductor Industries, is especially effective in protecting against high-energy transients such as those induced by lightning or motor contactors. Choose a TRANZORB with a voltage rating close to, but exceeding, the maximum V_S which the IXR100 will see. In combination, the coaxial bypass capacitors and TRANZORB provide a very high level of protection against transients and RFI.

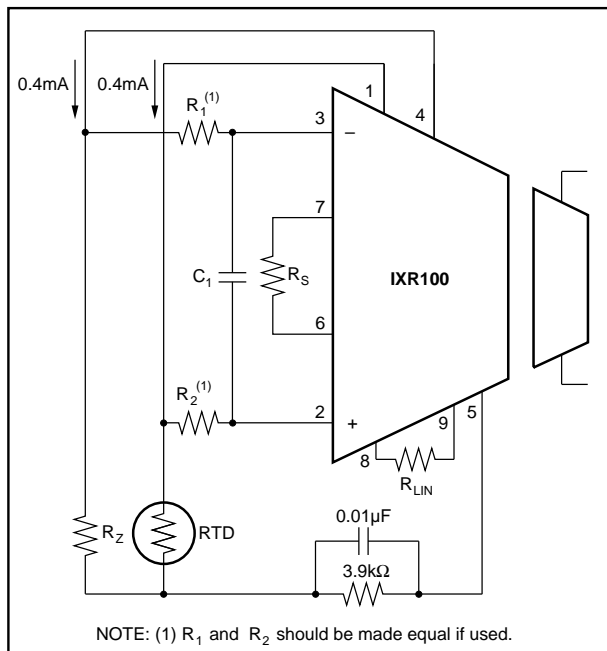

Figure 4. Optional Bandwidth-Limiting Circuitry.

INPUT BANDWIDTH LIMITING

Filtering at the input to the IXR100 is recommended where possible and can be done as shown in Figure 4. C_1 connected to pins 3 and 4 will reduce the bandwidth with a f_{-3dB} frequency given by:

$$f_{-3dB} = 0.159 / (R_1 + R_2 + RTD + R_Z) (C_1 + 3pF)$$

This method has the disadvantage of having f_{-3dB} vary with R_1 , R_2 , RTD , and R_Z may require large values of R_1 , and R_2 . R_1 and R_2 should be matched to prevent zero errors due to input bias current.

SIGNAL SUPPRESSION AND ELEVATION

In some applications it is desired to have suppressed zero range (span elevation) or elevated zero range (span suppression). This is easily accomplished with the IXR100 by using the current sources to create the suppression/elevation voltage. The basic concept is shown in Figure 5. In this example the sensor voltage is derived from RT (a thermistor, RTD or other variable resistance element) excited by one of the 0.4mA current sources. The other current source is used to create the elevated zero range voltage. Figures 6a, 6b, 6c and 6d show some of the possible circuit variations. These circuits have the desirable feature of noninteractive span and suppression/elevation adjustments.

NOTE: Use of the optional offset null (pins 10, 11, and 12) for elevation or suppression is not recommended. This trim technique is used only to trim the IXR100's output offset current.

MAJOR POINTS TO CONSIDER WHEN USING THE IXR100

1. The leads to R_S and R_{LIN} should be kept as short as possible to reduce noise pick-up and parasitic resistance. If the linearity correction feature is not desired, the R_{LIN} pins are left open.
2. $+V_S$ should be bypassed with a 0.01 μ F capacitor as close to the unit as possible (pins 18 to 28).
3. Always keep the input voltages within their range of linear operation, +2V to +4V ($\pm V_{IN}$ measured with respect to pin 5).

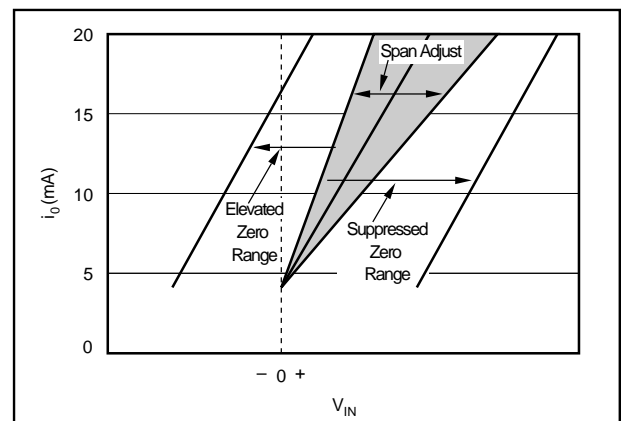

Figure 5. Elevation and Suppression Graph.

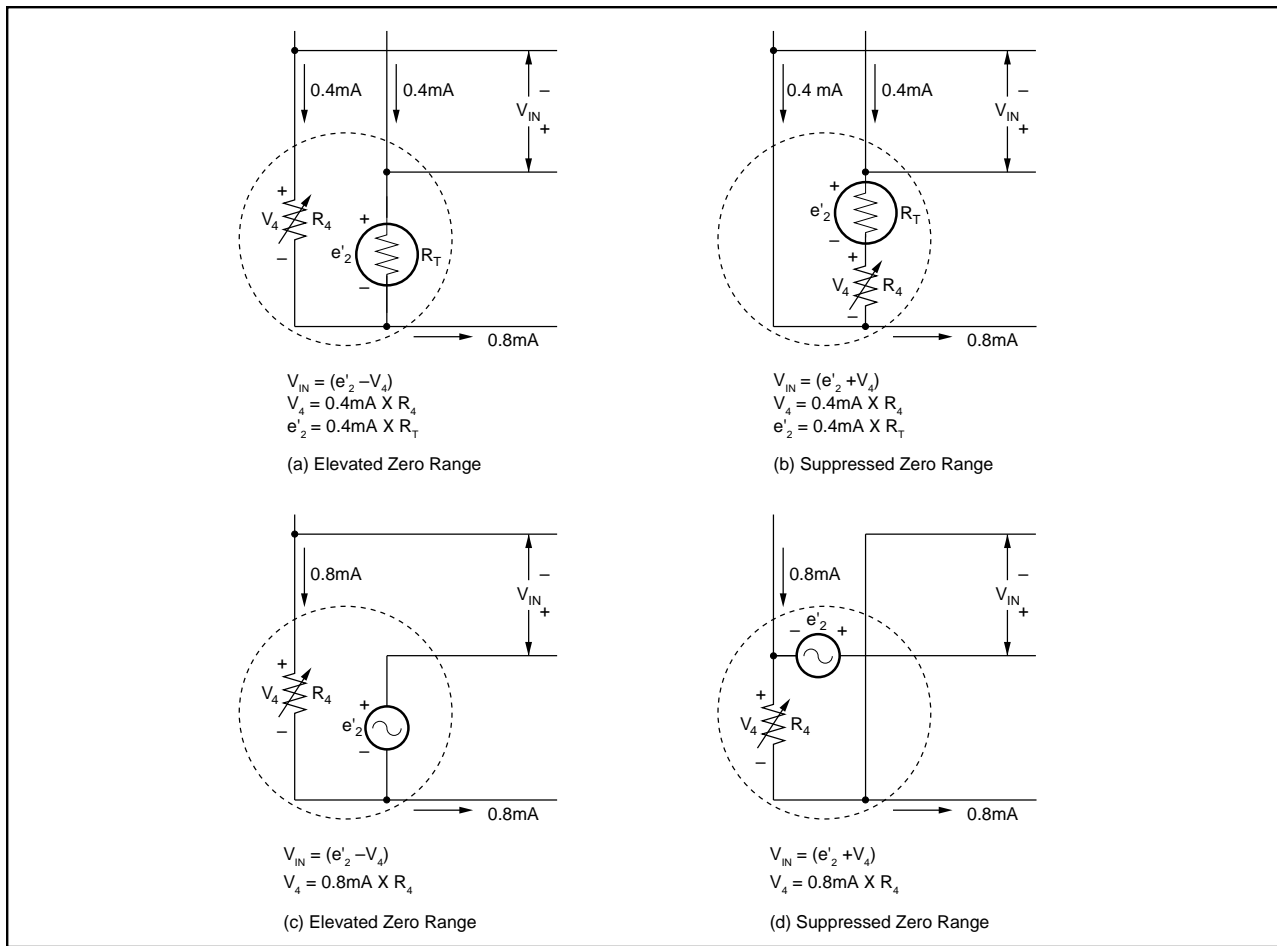

FIGURE 6. Elevation and Suppression Circuits.

- The maximum input signal level (ΔV_{IN}) is 1V with R_S open and is less as R_S decreases in value.
- Always return the current references to COM (pin 5) through an appropriate value of R_{CM} to keep V_{CM} within its operating range. Also, operate the current sources within their rated compliance voltage:

$$V_{IN} + \leq V_{IREF} \leq (\text{Com} + 7V)$$

- Always choose R_L , (including line resistance) so that the voltage between pins 18 and 28 ($+V_C$) remains within the 11.6V to 36V range as the output changes between 4mA and 20mA.
- It is recommended that a reverse polarity protection diode be used. This will prevent damage to the IXR100 caused by a transient or long-term reverse bias between pins 18 and 28. This diode can be connected in either of the two positions shown in Figure 7, but each connection has its trade-off. The series-connected diode will add to the minimum voltage at which the IXR100 will operate but offers loop and device protection against both reverse connections and transients. The reverse-biased diode in parallel with the IXR100 preserves 11.6V minimum operation and offers device protection, but could allow excessive current flow in the receiving instrument if the field leads are accidentally reversed. This is particularly

important if the receiving equipment has particularly low resistance or uses higher voltage supplies. In general, the series diode is recommended unless 12V operation is necessary. In either case a 1N4148 diode is suitable.

- Use a layout which minimizes parasitic inductance and capacitance, especially in high gain.

RECOMMENDED HANDLING PROCEDURES FOR INTEGRATED CIRCUITS

All semiconductor devices are vulnerable, in varying degrees, to damage from the discharge of electrostatic energy. Such damage can cause performance degradation or failure, either immediate or latent. As a general practice, we recommend the following handling procedures to reduce the risk of electrostatic damage.

- Remove static-generating materials, such as untreated plastic, from all areas where microcircuits are handled.
- Ground all operators, equipment, and work stations.
- Transport and ship microcircuits, or products incorporating microcircuits, in static-free, shielded containers.
- Connect together all leads of each device by means of a conductive material, when the device is not connected into a circuit.

- Control relative humidity to as high a value as practical (50% recommended).

RTD APPLICATIONS

The IXR100 has been designed with RTD applications specifically in mind. The following information provides additional information for those applications.

TWO- AND THREE-WIRE CONNECTIONS

The IXR100 performs well with two-wire and three-wire RTD connections commonly encountered in industrial monitoring and control.

In two-wire applications, the voltage drop between the RTD and the IXR100 can be nulled by proper adjustment of R_Z , but care must be taken that this voltage drop does not vary with ambient conditions. Such variation will appear as an apparent variation in the RTD resistance and therefore as a change in measured temperature. Also, the linearity correction will interpret this change as a variation and attempt to linearize both the actual RTD signal and the resistance changes in the signal lines. For these reasons, the line resistance between the RTD and the IXR100 should be minimized by keeping line lengths short and/or using large-gauge wires. This limitation does not apply for three-wire connections.

In three-wire applications, shown in Figure 7, the RTD and R_Z lead arrangements set up a pseudo-Kelvin connection to the RTD. This occurs because the currents through the three wires are set up in opposing directions and cancel IR drops in the RTD leads. The current sources are both modulated

equally, so that use of the linearity correction does not affect the cancellation. This action is true so long as the three wires are of the same length and gauge. Because most RTD leads are twisted and bundled, this requirement is usually met with no difficulty. Care must be taken that intermediate connections such as screw terminals do not violate this assumption by introducing unequal line resistances.

RTD ZERO ELEVATION AND SUPPRESSION

The IXR100 may be operated in zero-elevated and zero-suppressed ranges by simply offsetting R_Z . It may also be used in increase-decrease applications by interchanging the physical locations of the RTD and R_Z as shown in Figure 8. Use the same values of R_Z , R_{LIN} and R_S . Again, because the current sources are matched and are modulated equally, this connection has no effect on IXR100 performance, especially in three-wire applications.

OPEN CIRCUIT DETECTION

In some applications of the IXR100, the RTD will be located remotely. In these cases, it is possible for open circuits to develop. The IXR100 responds in the following manner to breaks in each lead. The following connections refer to the RTD connections shown in Figure 7.

TERMINAL OPEN	$I_{out}^{(1)}$
1	32mA
2	3.6mA
3	32mA

NOTE: (1) Approximate value.

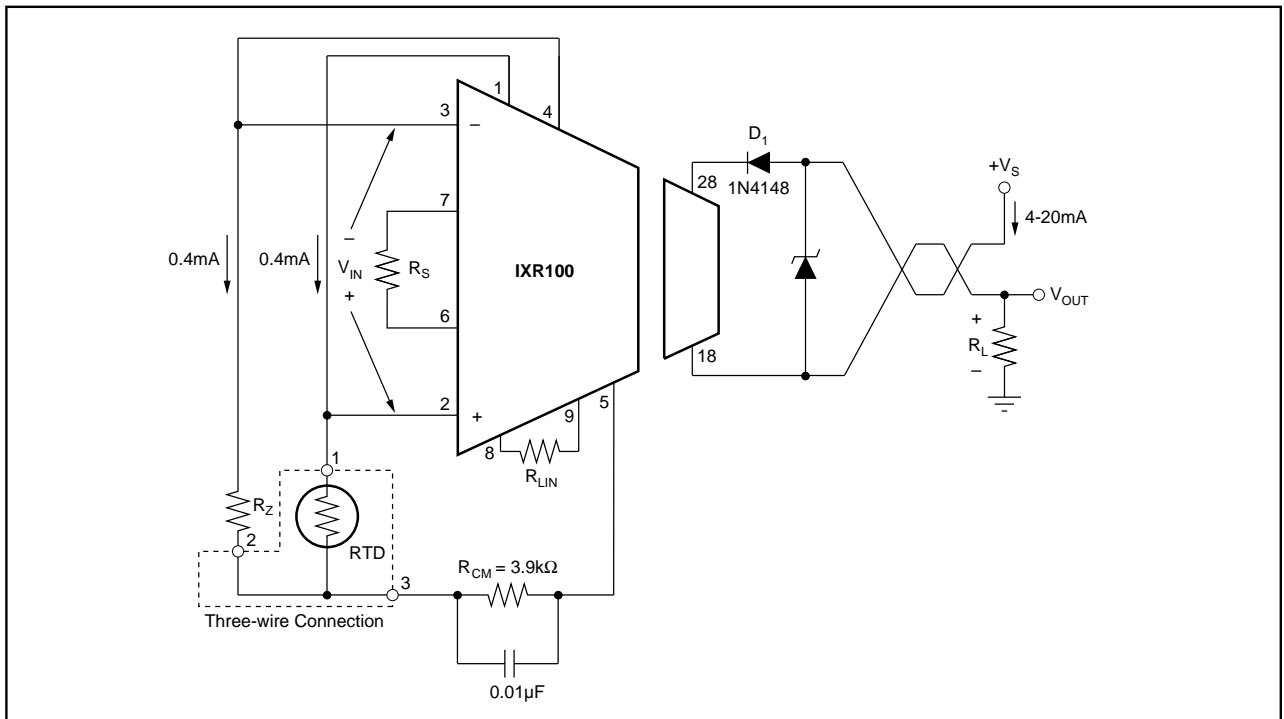

FIGURE 7. Basic 3-Wire RTD Connection for Increase-Increase Action.

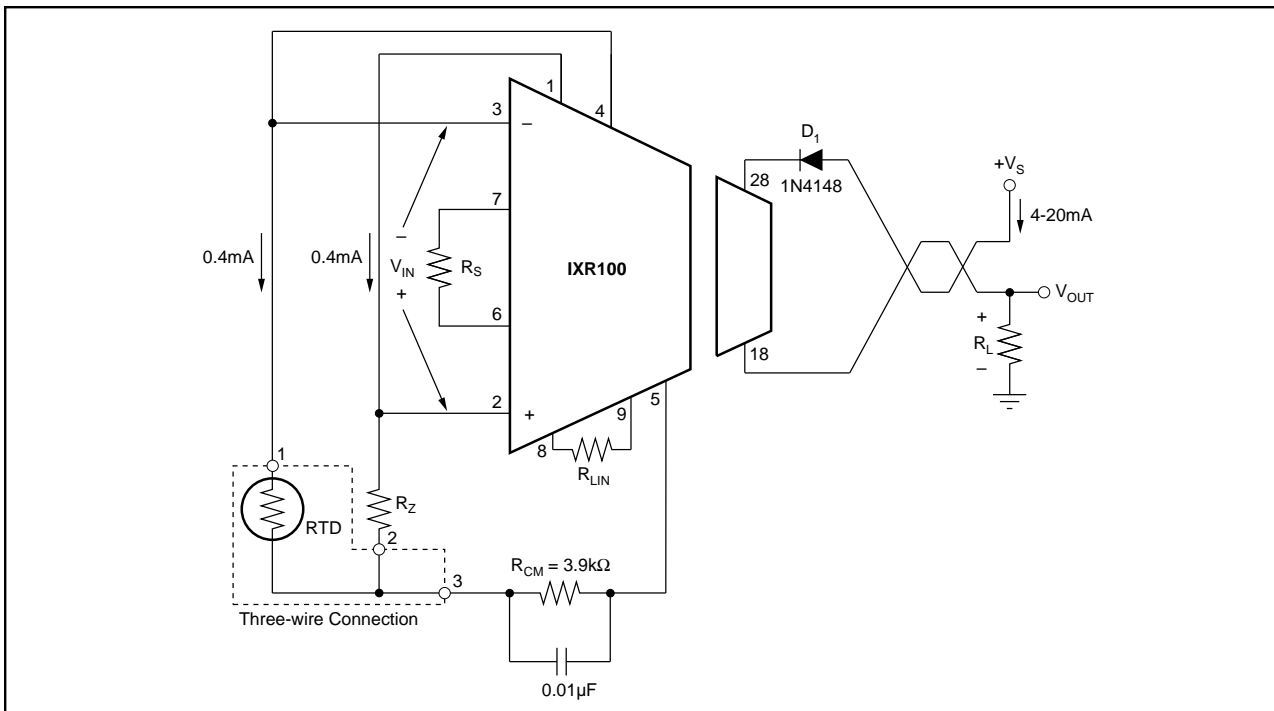

FIGURE 8. Basic 3-Wire RTD Connection for Increase-Decrease Action.

OTHER APPLICATIONS

In instances where the linearization capability of the IXR100 is not required, it can still provide improved performance in several applications. Its small size, wide compliance voltage, low zero and span drift, high PSRR, high CMRR and excellent linearity makes the IXR100 ideal for a variety of other isolated two-wire transmitter applications. It can be used by OEMs producing different types of isolated transducer transmitter modules and by data acquisition systems manufacturers who gather transducer data. Current mode transmission greatly reduces noise interference. The two-wire nature of the device allows economical signal conditioning at the transducer. Thus, the IXR100 is, in general, very suitable for a wide variety of applications. Some examples, including an isolated non-linearized Pt100 case, follow.

EXAMPLE 1

Pt100 RTD without linearization shown in Figure 9.

Given a process with temperature limits of +25°C and +150°C, configure the IXR100 to measure the temperature with a Pt100 RTD which produces 109.73Ω at 25°C and 157.31Ω at 150°C (obtained from standard RTD tables). Transmit 4mA for +25°C and 20mA for +150°C. The change in resistance of the RTD is 47.6Ω. When excited with a 0.4mA current source ΔV_{IN} is $0.4\text{mA} \times 47.6\Omega = 19\text{mV}$.

$$R_s = \frac{40}{0.016/(\Delta V_{IN}) - 0.016} \Omega \quad (1)$$

From Equation (1), $R_s = 48.5\Omega$. Span adjustment (calibration) is accomplished by trimming R_s .

In order to make the lower range limit of 25°C correspond to the output lower range limit at 4mA, the input circuitry shown in Figure 9 is used. V_{IN} must be 0V at 25°C and R_Z is chosen to be equal to the RTD resistance at 25°C, or 109.73Ω. Computing R_{CM} and checking CMV:

$$\text{At } +25^\circ\text{C}, V_{IN+} = 43.9\text{mV}$$

$$\text{At } +150^\circ\text{C}, V_{IN+} = 62.9\text{mV}$$

Since both V_{IN+} and V_Z are small relative to the desired 2V common-mode voltage, they may be ignored in computing R_{CM} as long as the CMV is met.

$$R_{CM} = 3\text{V}/0.8\text{mA} = 3.75\text{k}\Omega$$

$$V_{IN+ \text{ min}} = 3\text{V} + 0.0439\text{V}$$

$$V_{IN+ \text{ max}} = 3\text{V} + 0.0629\text{V}$$

$$V_{IN-} = 3\text{V} + 0.0439\text{V}$$

EXAMPLE 2

Thermocouple shown in Figure 10.

Given a process with temperature (T_1) limits of 0°C and +1000°C, configure the IXR100 to measure the temperature with a Type J thermocouple that produces a 58mV change for 1000°C change. Use a semiconductor diode for a cold junction compensation to make the measurement relative to 0°C. This is accomplished by supplying a compensating voltage, equal to that normally produced by the thermocouple with its "cold junction" (T_2) at ambient. At +25°C this is 1.28mV (from thermocouple tables with reference junction at 0°C). Typically, at $T_2 = +25^\circ\text{C}$, $V_D = 0.6\text{V}$ and

$\Delta V_D/\Delta T = -2\text{mV}/^\circ\text{C}$. R_5 and R_6 form a voltage divider for the diode voltage V_D . The divider values are selected so that the gradient $\Delta V_D/\Delta T$ equals the gradient of the thermocouple at the reference temperature. At $+25^\circ\text{C}$ this is approximately $-52\mu\text{V}/^\circ\text{C}$ (obtained from standard thermocouple table); therefore,

$$\begin{aligned} \Delta V_{TC}/\Delta T &= (\Delta V_D/\Delta T)(R_6/(R_5 + R_6)) & (2) \\ -52\mu\text{V}/^\circ\text{C} &= (-2000\mu\text{V}/^\circ\text{C})(R_6/(R_5+R_6)) \end{aligned}$$

R_5 is chosen as $3.74\text{k}\Omega$ to be much larger than the resistance of the diode. Solving for R_6 yields 100Ω .

Transmit 4mA for $T_1 = 0^\circ\text{C}$ and 20mA for $T_1 = +1000^\circ\text{C}$. Note: $V_{IN} = V_{IN+} - V_{IN-}$ indicates that T_1 is relative to T_2 . The input full scale span is 58mV . R_S is found from Equation (1) and equals 153.9Ω .

R_4 is chosen to make the output 4mA at $T_{TC} = 0^\circ\text{C}$ ($V_{TC} = 1.28\text{mV}$) and $T_D = 25^\circ\text{C}$ ($V_D = 0.6\text{V}$).

V_{TC} will be -1.28mV when $T_{TC} = 0^\circ\text{C}$ and the reference junction is at $+25^\circ\text{C}$. V_4 must be computed for $T_D = +25^\circ\text{C}$ to make $V_{IN} = 0\text{V}$.

$$V_{D(25^\circ\text{C})} = 600\text{mV}$$

$$V_{IN(25^\circ\text{C})} = 600\text{mV} (100/3740) = 16.0\text{mV}$$

$$V_{IN} = V_{IN+} - V_{IN-} = V_{TC} + V_4 - V_{IN-}$$

$$\text{With } V_{IN} = 0 \text{ and } V_{TC} = -1.28\text{mV},$$

$$V_4 = V_{IN+} - V_{TC}$$

$$V_4 = 16.0\text{mV} - (-1.28\text{mV})$$

$$0.4\text{mA} (R_4) = 17.28\text{mV}$$

$$R_4 = 43.2\Omega$$

THERMOCOUPLE BURN-OUT INDICATION

In process control applications it is desirable to detect when a thermocouple has burned out. This is typically done by forcing the two-wire transmitter current to the upper or lower limit when the thermocouple impedance goes very high. The circuits of Figures 10, 11 and 12 inherently have down scale indication. When the impedance of the thermocouple gets very large (open) the bias current flowing into the $+$ input (large impedance) will cause I_O to go to its lower range limit value (about 3.6mA). If up scale indication is desired, the circuit of Figure 13 should be used. When the T_C opens, the output will go to its upper range limit value (about 32mA or higher).

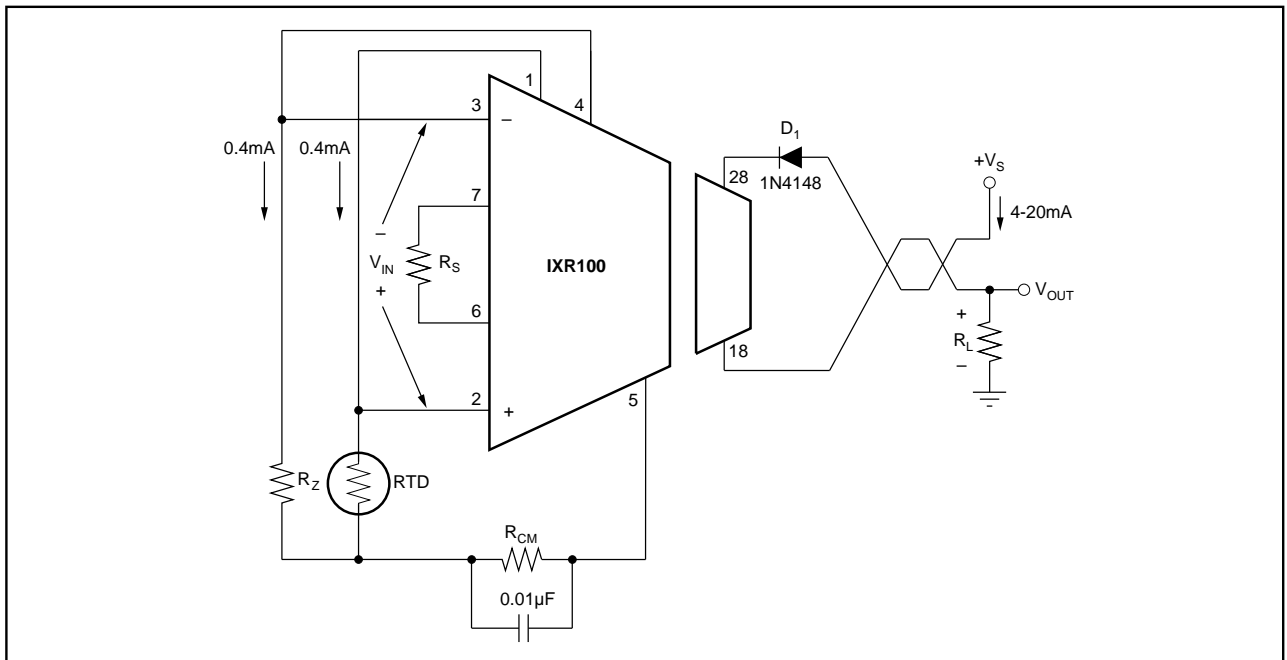

FIGURE 9. Pt100 RTD Without Linearization.

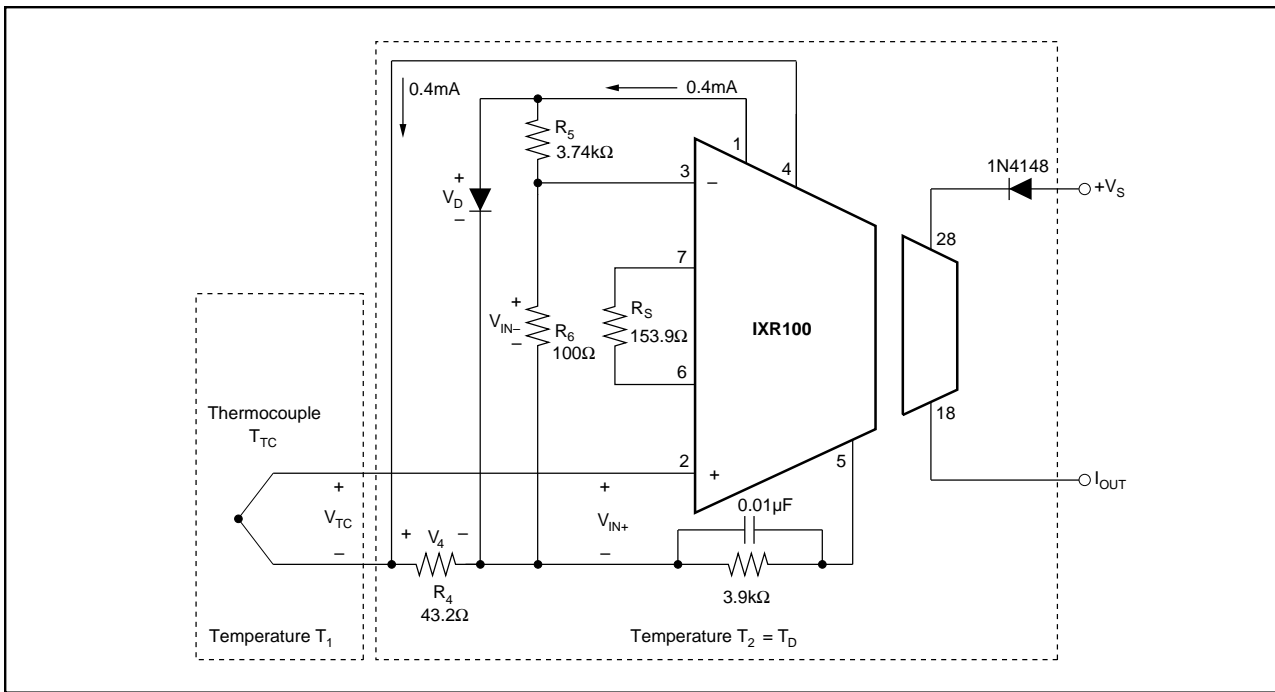

FIGURE 10. Thermocouple Input Circuit with Two Temperature Regions and Diode (D) Cold Junction Compensation.

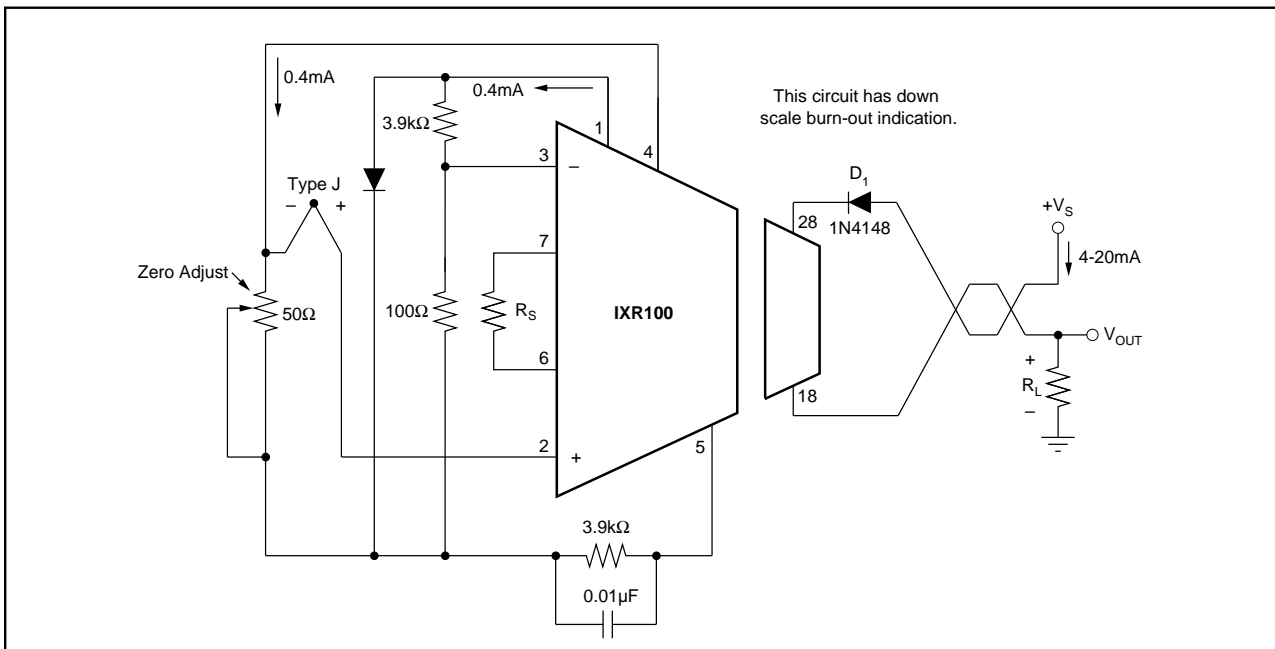

FIGURE 11. Thermocouple Input with Diode Cold Junction Compensation and Down Scale Burn-out Indication.

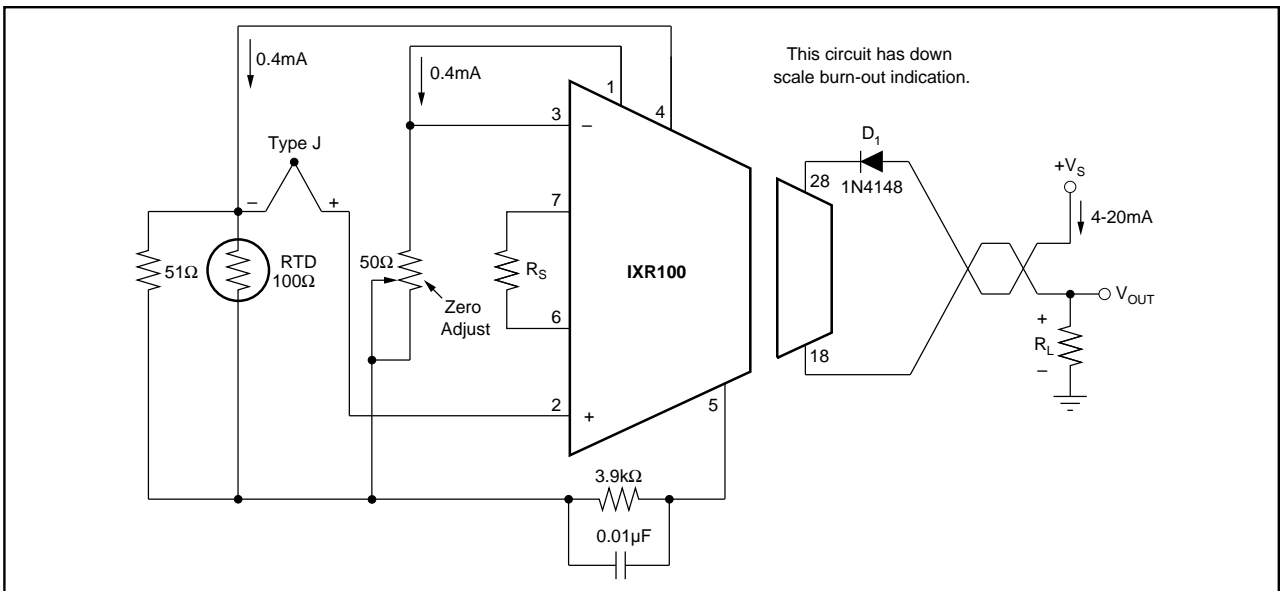

FIGURE 12. Thermocouple Input with RTD Cold Junction Compensation and Down Scale Burn-out Indication.

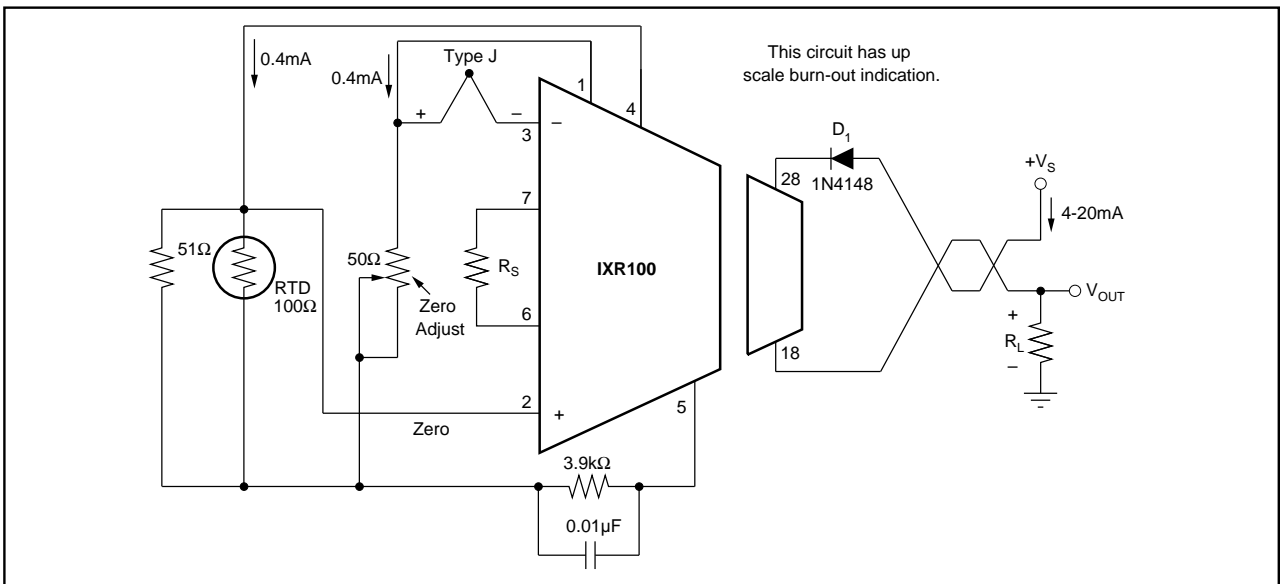

FIGURE 13. Thermocouple Input with RTD Cold Junction Compensation and Up Scale Burn-out Indication.

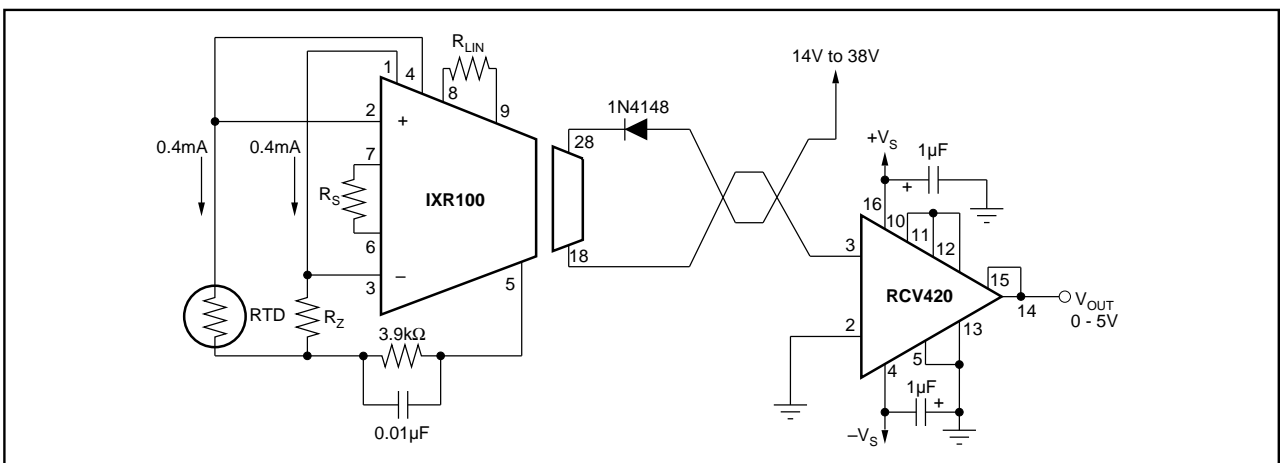

FIGURE 14. Isolated 4-20mA Instrument Loop.

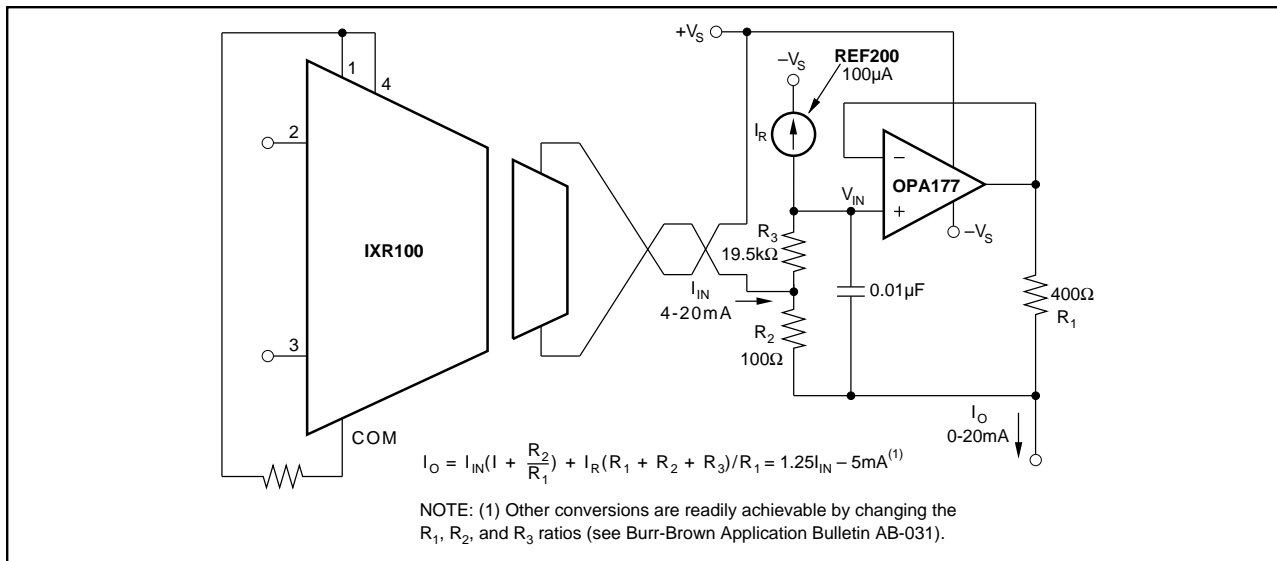

FIGURE 15. 4-20mA to 0-20mA Output Converter.