



Matrix any 4 local Component A/V sources

4x4 Component w/Audio CAT5 Matrix

Matrix any 4 Component sources to 4 remote displays over CAT5

The Gefen 4x4 Component/Audio CAT5 Matrix offers unprecedented flexibility and convenience by routing high definition video and analog/digital audio from any of four Component video sources to any of 4 remote displays over inexpensive, standard CAT5 cabling.

Each remote display has a control box that allows the viewer to select any of the 4 video sources and control that source via an IR remote control as if the viewer was standing in the room where the source originates.

Full High-Resolution HDTV signals are supported up to a resolution of 1080p at a maximum distance of 1000 feet. The Gefen 4x4 Component/Audio CAT5 Matrix works with any Component video source including DVD players, cable boxes, and satellite set-top boxes that connect to a Component display. Every source is accessible at all times by any display by selecting it with the IR remote.

How It Works

You simply connect up to 4 local Component video and analog/digital audio sources to the CAT5-Matrix's inputs. Connect the included 1-foot loopback cables into the upper board for the CAT5 extension function. Then run each of your CAT5 cables from the Matrix to the remote displays. At each remote display, terminate the CAT5 cable run with a Component/Audio CAT5 Receiver device. Connect each Receiver to a display and your analog/digital audio equipment and you're all set.

Note:

The Gefen 4x4 Component/Audio CAT5 Matrix can receive both analog L+R stereo or S/PDIF digital audio, and output all audio formats at the receiver/display end: Toslink, S/PDIF, and analog L + R stereo audio.

Features:

- Switches easily between any four component/audio sources
- Sends up to four video inputs to any four remote displays
- Maintains 1920 x 1200, 1080p, and 2k resolution video
- Extends video up to 1000 feet over CAT-5 cable
- Discrete IR remote (included)
- Serial RS-232 remote port
- Rack ears included

Specifications:

- Video Amplifier Bandwidth: 350 MHz
- Input Video Signal: 1.2 volts p-p
- Video Resolutions: 1080p
- Video Connector: RCA-style RGB x 3
- Analog Audio Connector: RCA-style L + R (Stereo)
- Digital Audio Connector: S/PDIF Coax. (Matrix), S/PDIF & Toslink (Receiver)
- Link Connector: RJ-45 Shielded
- Remote Control Port: RS232 female, mini-stereo
- Power Supply Sender: 24V DC (60 Watts) Receiver 5V DC (5 Watts)
- Dimensions Sender: 1.7"W x 3.5"H x 5.875"D
- Dimensions Receiver: 6.6"W x 1.3"H x 2.7"D
- Shipping Weight: 16 lbs.

Package Includes:

- 1 x 4x4 Component/Audio CAT5 Matrix
- 4 x Component/Audio over CAT-5 Receiver Units
- 4 x RMT-4 Infrared Remote Controls
- 4 x 1-foot 5 RCA Component Video/Audio cables (for selecting CAT5 transmission)
- 4 x 6-foot 5 RCA Component Video/Audio cables (for connecting Matrix to sources)
- 4 x 5V DC Power Supplies (for Receivers)
- 1 x 24V DC Power Supply (for Matrix)
- Rack Ears
- User's Manual



EXT-COMPAUD-CAT5-444

Gefen

4x4 Component Matrix Over CAT-5

EXT-COMPAUD-CAT5-444

User Manual



www.gefen.com

1080P
PROGRESSIVE

DTV

ASKING FOR ASSISTANCE

Technical Support:

Telephone (818) 772-9100
(800) 545-6900

Fax (818) 772-9120

Technical Support Hours:

8:00 AM to 5:00 PM Monday thru Friday.

Write To:

Gefen Inc.
c/o Customer Service
20600 Nordhoff St
Chatsworth, CA 91311

www.gefen.com
support@gefen.com

Notice

Gefen Inc. reserves the right to make changes in the hardware, packaging and any accompanying documentation without prior written notice.

4x4 Component Matrix Over CAT-5 is a trademark of Gefen Inc.

CONTENTS

- 1 Introduction**
- 2 Operation Notes**
- 3 Features**
- 4 4x4 Component Matrix Over CAT-5 Front Panel Layout**
- 5 4x4 Component Matrix Over CAT-5 Front Panel Descriptions**
- 6 4x4 Component Matrix Over CAT-5 Back Panel Layout**
- 7 4x4 Component Matrix Over CAT-5 Back Panel Descriptions**
- 8 4x4 Component Audio Over CAT-5 Receiver Panel Layout**
- 9 4x4 Component Audio Over CAT-5 Receiver Panel Description**
- 10 RMT-16IR Remote Description**
- 11 RMT-4IR Remote Description**
- 12 Connecting And Operating The 4x4 Component Matrix Over CAT-5**
- 13 Operating The 4x4 Component Matrix Over CAT-5 Receiver**
- 14 Adjusting The 4x4 Component Matrix Over CAT-5 Receiver**
- 15 RMT-4IR Remote IR Code Configuration**
- 16 RS-232 Serial Control Interface**
- 17 Network Cable WIRing Diagram**
- 18 Rack Mount Installation**
- 19 Specifications**
- 20 Warranty**

INTRODUCTION

Congratulations on your purchase of the 4x4 Component Matrix Over CAT-5. Your complete satisfaction is very important to us.

Gefen

Gefen delivers innovative, progressive computer and electronics add-on solutions that harness integration, extension, distribution and conversion technologies. Gefen's reliable, plug-and-play products supplement cross-platform computer systems, professional audio/video environments and HDTV systems of all sizes with hard-working solutions that are easy to implement and simple to operate.

The Gefen 4x4 Component Matrix Over CAT-5

The Gefen 4x4 Component/Audio CAT5 Matrix offers unprecedented flexibility and convenience by routing high definition video and analog/digital audio from any of four Component video sources to any of 4 remote displays over inexpensive, standard CAT5 cabling.

Each remote display has a control box that allows the viewer to select any of the 4 video sources and control that source via an IR remote control as if the viewer was standing in the room where the source originates.

Full High-Resolution HDTV signals are supported up to a resolution of 1080p at a maximum distance of 1000 feet. The Gefen 4x4 Component/Audio CAT5 Matrix works with any Component video source including DVD players, cable boxes, and satellite set-top boxes that connect to a Component display. Every source is accessible at all times by any display by selecting it with the IR remote.

How It Works

You simply connect up to 4 local Component video and analog/digital audio sources to the CAT5-Matrix's inputs. Connect the included 1-foot loop back cables into the upper board for the CAT5 extension function. Then run each of your CAT5 cables from the Matrix to the remote displays. At each remote display, terminate the CAT5 cable run with a Component/Audio CAT5 Receiver device. Connect each Receiver to a display and your analog/digital audio equipment and you're all set.

OPERATION NOTES

READ THESE NOTES BEFORE INSTALLING OR OPERATING THE 4X4 COMPONENT MATRIX OVER CAT-5

- The extender functionality of the 4x4 Component Matrix Over CAT-5 requires the use of the supplied 1 foot component video and audio jumper cables. These cables must be used to connect the component video and audio output ports to the component video and audio extension input ports. Please see page 12 for details.
- For 1080p video, maximum extension is 1000 feet (300 meters).
- IR repeater functionality is only from the receiving unit to the sending unit. IR data cannot be transmitted from the sending unit to the receiving unit.
- A single CAT cable is needed for each extension. Gefen recommends using solid core CAT-5e cabling. Termination should adhere to the TIA/EIA-568-B specification. Please see page 17 for more details.

FEATURES

Features

- Switches easily between any four component/audio sources
- Sends up to four video inputs to any four remote displays
- Maintains 1920 x 1200, 1080p, and 2k resolution video
- Extends video up to 1000 feet over CAT-5 cable
- Discrete IR remote (included)
- Serial RS-232 remote port
- Rack ears included

Package Includes

- (1) 4x4 Component/Audio CAT5 Matrix
- (4) Component/Audio over CAT-5 Receiver Units
- (4) RMT-4 Infrared Remote Controls
- (4) 1 Foot 5 RCA Component Video/Audio Cables (for selecting CAT5 transmission)
- (4) 6 Foot 5 RCA Component Video/Audio cables (for connecting Matrix to sources)
- (4) 5V DC Power Supplies (for Receivers)
- (1) 24V DC Power Supply (for Matrix)
- (1) Rack Ears
- (1) User's Manual

4X4 COMPONENT MATRIX OVER CAT-5 FRONT PANEL LAYOUT

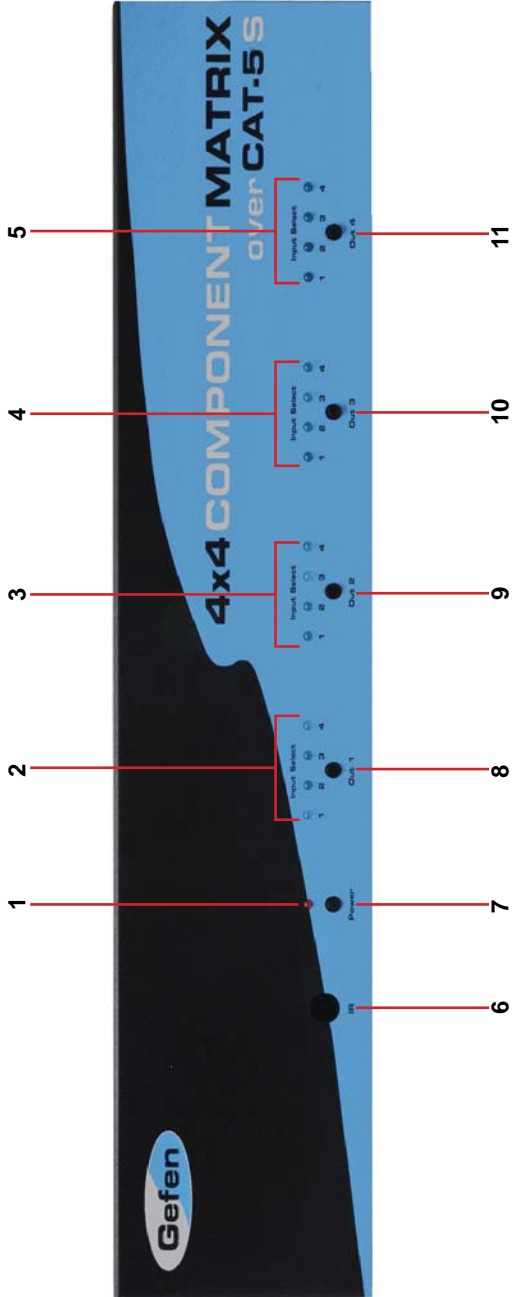

4X4 COMPONENT MATRIX OVER CAT-5 FRONT PANEL DESCRIPTIONS

1 Power LED Indicator

This LED will become active once the included 24V DC power adapter is properly connected.

2 Output 1 Source LED Indicator

The currently selected source being displayed on Monitor Output 1 will be visually acknowledged by an active LED. There are 4 LED's, one for each input source.

3 Output 2 Source LED Indicator

The currently selected source being displayed on Monitor Output 2 will be visually acknowledged by an active LED. There are 4 LED's, one for each input source.

4 Output 3 Source LED Indicator

The currently selected source being displayed on Monitor Output 3 will be visually acknowledged by an active LED. There are 4 LED's, one for each input source.

5 Output 4 Source LED Indicator

The currently selected source being displayed on Monitor Output 4 will be visually acknowledged by an active LED. There are 4 LED's, one for each input source.

6 IR Receiver

This port will receive IR commands from the included RMT-16IR remote control.

7 Power Button

Pressing this button while the unit is on will place the unit in stand-by mode. Pressing this button again while the unit is in stand-by will turn it on.

8 Output 1 Source Button

Each press of this button will cycle through the 4 inputs which will be displayed on the Monitor Output 1.

9 Output 2 Source Button

Each press of this button will cycle through the 4 inputs which will be displayed on the Monitor Output 2.

10 Output 3 Source Button

Each press of this button will cycle through the 4 inputs which will be displayed on the Monitor Output 3.

11 Output 4 Source Button

Each press of this button will cycle through the 4 inputs which will be displayed on the Monitor Output 4.

4X4 COMPONENT MATRIX OVER CAT-5 BACK PANEL LAYOUT

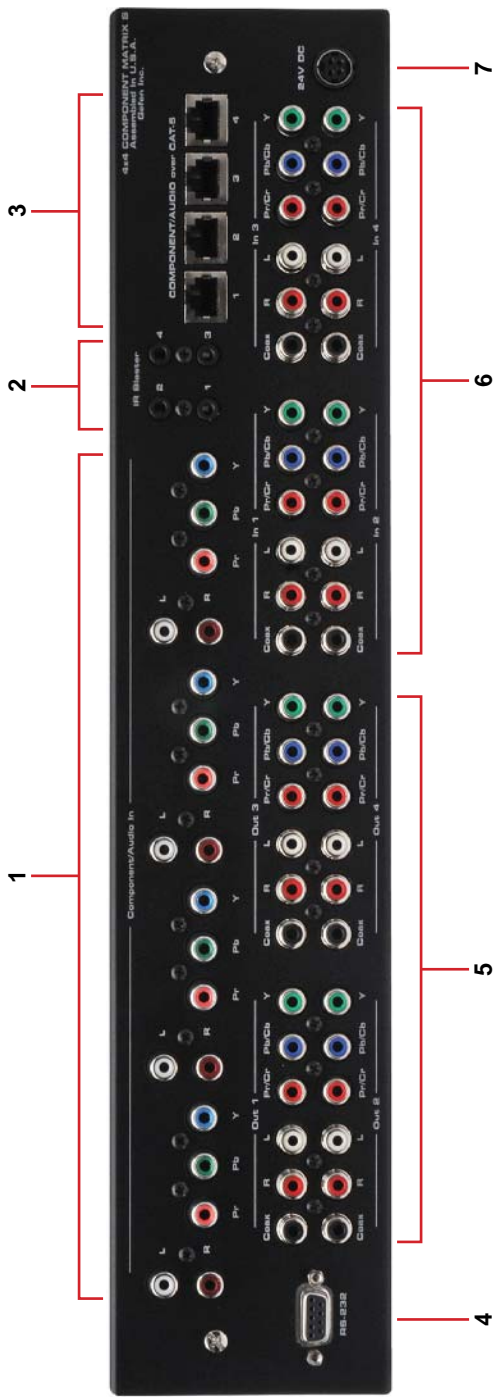

4X4 COMPONENT MATRIX OVER CAT-5 BACK PANEL DESCRIPTIONS

1 Component With Audio Extension Input

Connect the included jumper cables between the Component With Audio Outputs (Item 5 on this page) and these inputs. Inputs include component video, analog audio, and digital audio connectors. There are 4 inputs that are used in conjunction with the CAT-5 output ports for extension.

2 IR Blaster Outputs

Connect IR emitters/blaster (sold separately, part# EXT-2IREMIT) to these output ports. Each output is linked to one of the extension receivers. IR information is relayed from each remote location and is sent to these blasters for control of local equipment from the extended location. Place the blaster “eye” on or near the IR receiver of the connected equipment.

3 CAT-5 Extension Ports

Connect user supplied CAT-5e cables between these ports and the 4x4 Component Audio Over CAT-5 Receivers at remote locations. These cables will transmit the component and audio signals to the remote locations while receiving IR data from each receiver.

4 RS-232 Serial Control Interface

This port is used for control of the 4x4 Component Audio Over CAT-5 by RS-232 serial communication. Please see page 14 for more information.

5 Component With Audio Outputs

Connect the included jumper cables between the Component With Audio Extension inputs (Item 1 on this page) and these inputs. Outputs include component video, analog audio, and digital audio connectors. There are 4 outputs.

6 Component With Audio Inputs

Connect the component video and audio source devices to these input ports using the supplied component and audio cables. Up to 4 sources can be connected at one time. Inputs include component video, analog audio, and digital coaxial connectors.

7 24V DV Power Input

Connect the included 24V DC power supply to this input.

4X4 COMPONENT AUDIO OVER CAT-5 RECEIVER PANEL LAYOUT

Front Panel

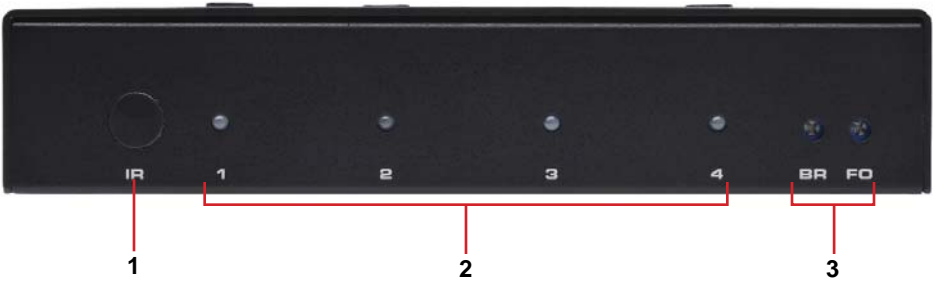

Back Panel



Top Panel



4X4 COMPONENT AUDIO OVER CAT-5 RECEIVER

PANEL DESCRIPTION

1 IR Receiver

This receiver will receive commands from both the included RMT-4IR remote control and from other commercial IR remote controls. IR commands from commercial IR remote controls are relayed from this unit back to the 4x4 Component Audio Over CAT-5 sending unit where they will be output by the attached IR Blasters.

2 Selected Source LED

The currently selected source that is being displayed on the attached monitor will be visually acknowledged by an active LED. There are 4 LEDs, one for each source.

3 Brightness & Focus Adjustment Trim Pots

Brightness and focus Trim Pots are available for fine tuning the output video signal. Please see page 14 for more information and instructions on usage.

4 5V DV Power Input

Connect the included 5V DV power adapter to this input. Once a proper connection is made the power LED indicator should become active.

5 Component Video Output

Connect the component display to this output using user supplied cables.

6 CAT-5 Extension Port

Connect a user supplied CAT-5e cable between the CAT-5 extension ports on the 4x4 Component Audio Over CAT-5 sending unit and this port.

7 Analog RCA Stereo Audio Output

Connect this output to either the display's analog audio input or a receiver's analog audio input using user supplied analog audio cables.

8 Digital Coaxial Audio output

Connect this output to either the display's digital coaxial audio input or a receiver's digital coaxial audio input using a user supplied digital coaxial audio cable.

9 Digital Optical Audio output

Connect this output to either the display's digital optical audio input or a receiver's digital optical audio input using a user supplied digital optical audio cable.

10 IR Extension Port

Connect the optional IR Receiver Extension (part# EXT-RMT-EXTIR) to this port.

11 Direct Select Buttons

Use buttons 1 through 4 to select what source the connected display will be view.

RMT-16IR REMOTE DESCRIPTION

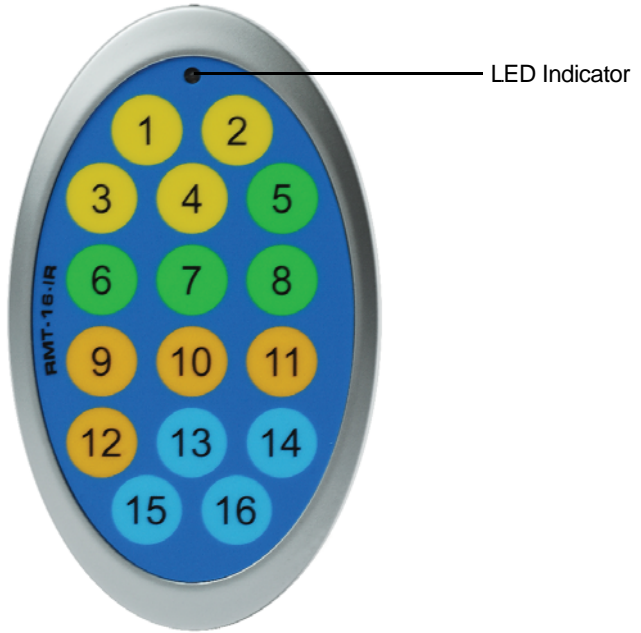

The RMT-16IR remote control will allow the user to select which source each of the 4 connected displays will be viewing at the source location. Each of the 4 displays are assigned a group of 4 buttons that correspond to the 4 source inputs. Please use the information below when selecting the desired source for each display.

RMT-16IR Button	Display	Source
1	1	1
2	1	2
3	1	3
4	1	4
5	2	1
6	2	2
7	2	3
8	2	4
9	3	1
10	3	2
11	3	3
12	3	4
13	4	1
14	4	2
15	4	3
16	4	4

RMT-4IR REMOTE DESCRIPTION



Each extended location with a 4x4 Component Matrix Over CAT-5 Receiver can use an RMT-4IR remote control to choose which source will be viewed by the attached display. Pressing the numbered buttons will switch to the source connected to the same numbered input on the 4x4 Component Matrix Over CAT-5.

To use the RMT-4 IR remote, remove the battery cover on the back of the remote to reveal the battery compartment. Insert the included battery into the open battery slot. The positive (+) should be facing up. Ensure that the both dip switches are in the OFF position. Replace the battery cover. The remote ships with 2 batteries. One battery is needed for operation and the other battery is complimentary.

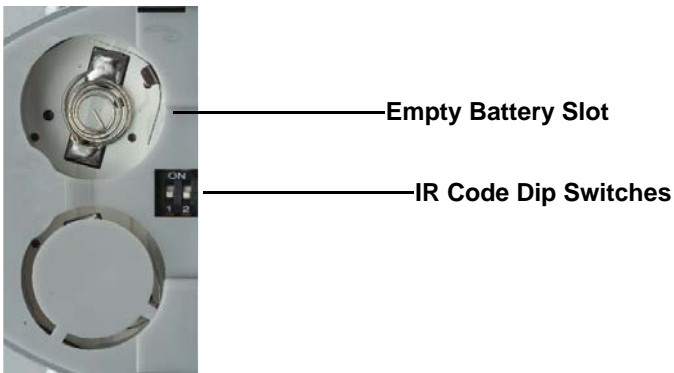

CONNECTING AND OPERATING THE 4X4 COMPONENT MATRIX OVER CAT-5

How to Connect the 4x4 Component Matrix Over CAT-5

1. Connect up to 4 component video/audio source devices to the 4x4 Component Matrix Over CAT-5 sending unit using the included 5 RCA component video/audio cables.
2. Optionally, connect up to 4 digital coaxial audio source devices to the 4x4 Component Matrix Over CAT-5 sending unit using one of the RCA cables from the supplied 5 RCA component/audio cable.
3. Using the included 5 RCA component video/audio jumper cables, connect the Component Video/Audio Output ports to the Component Video/Audio Extension Input ports. Please see the panel layout on page 6 for the locations of these ports.
4. If using digital coaxial audio, connect the digital coaxial outputs to the LEFT ANALOG connector of each of the Component Video/Audio Extension Input ports. This port will automatically detect the digital audio and send it to the appropriate digital output ports on the 4x4 Component Audio Over CAT-5 receiving units.
5. Connect the 4x4 Component Audio Over CAT-5 sending and receiving units together using user supplied CAT-5e cables.

NOTE: If field terminating CAT cabling please ensure that terminations adhere to the TIA/EIA-568-B specification. Please see page 15 more information.

6. Connect a component display to each of the 4x4 Component Matrix Over CAT-5 receiving units using user supplied component cables.
7. Connect analog/digital audio to either the component display or a separate audio receiver.

NOTE: The 4x4 Component Matrix Over CAT-5 receiver units will cross-convert analog/digital stereo audio formats. If the source audio is 2 channel digital or analog, both analog and digital outputs will be active on the receiver units. If the source audio is digital multi-channel bit-stream, only audio from the digital outputs will be active on the receiver units.

8. Connect the included 24V DC power supply to the 4x4 Component Matrix Over CAT-5 sending unit. Connect each of the included 5V DC power supplies to each of the 4x4 Component Matrix Over CAT-5 receiving units.
9. Power on the displays and source devices.

OPERATING THE 4X4 COMPONENT MATRIX OVER CAT-5 RECEIVER

The 4x4 Component Matrix Over CAT-5 Receiver can be placed at each remote location. Each receiver can switch between the four sources connected to the 4x4 Component Over CAT-5 Matrix sender. The unit has two methods of switching using either the direct selection buttons or the RMT-4IR remote control.

Switching Using The Direct Selection Buttons

Each numbered button on the top panel of the 4x4 Component Matrix Over CAT-5 Receiver corresponds to component inputs 1 through 4 on the 4x4 Component Matrix Over CAT-5 sending unit.

1. Press the button on the top panel of the receiver that corresponds to the input that you wish to view.

Switching Using The Direct Selection Buttons

The RMT-4IR remote has 4 numbered buttons that correspond to inputs 1 through 4 on the 4x4 Component Matrix Over CAT-5 sender unit.

1. Press the button on the RMT-4IR remote control that corresponds to the input that you wish to view.

Using the IR Repeater Feature

Each 4x4 Component Matrix Over CAT-5 receiver can receive commands from standard consumer IR remote controls and send them back to the sender unit for output through the IR emitters/blasters. This allows the user to control the equipment connected to the sender from the remote location. The IR emitters (part# EXT-2IREMIT) are sold separately.

1. Connect an IR blaster to the IR Blaster output port on the rear panel of the 4x4 Component Matrix Over CAT-5 sender unit. Each of the 4 numbered output ports correspond to each of the 4 CAT-5 extension ports. Connect the IR emitter to the same port number of the remote receiver that you wish to use.
2. Remove the adhesive from the IR blaster's emitter eye and place it on or near IR receiver of the connected equipment.
3. Using the IR remote control of the equipment that has the IR emitter attached to it, send commands to the 4x4 Component Matrix CAT-5 receiver at the remote location. These IR command will be routed back to the sender and output through the IR blasters to control the attached source device.

ADJUSTING THE 4X4 COMPONENT MATRIX OVER CAT-5 RECEIVER

Each 4x4 Component Matrix Over CAT-5 Receiver has two trim pots used to adjust the brightness and focus of the video output. These adjustment trim pots are located on the front panel of each unit. Please use the guidelines below for adjusting both trim pots.

Brightness

If the image appears too dim or too bright, adjust the brightness trim pot.

1. Insert a small flathead adjustment tool into the trim pot.
2. Turn the trim pot in a clockwise fashion until the trim pot stops turning. Do not force the trim pot beyond this point as it may break and will render the trim pot useless.
3. Turn the trim pot in millimeter increments in a counter-clockwise fashion until the desired brightness is reached.
4. Remove the trim pot adjustment tool.

Focus

If the image is out of focus, or the colors are smeared, adjust the focus trim pot.

1. Insert a small flathead adjustment tool into the trim pot.
2. Turn the trim pot in a clockwise fashion until the trim pot stops turning. Do not force the trim pot beyond this point as it may break and will render the trim pot useless.
3. Turn the trim pot in millimeter increments in a counter-clockwise fashion until the desired focus is reached.
4. Remove the trim pot adjustment tool.

RMT-4IR REMOTE IR CODE CONFIGURATION

How to Resolve IR Code Conflicts

In the event that IR commands from other remote controls conflict with the supplied RMT-4IR remote control, changing the remote channel will alleviate this issue. The RMT-4IR remote control and the 4x4 Component Matrix Over CAT-5 receiver have DIP SWITCHES for configuring the remote channel that both units use to communicate. These settings must match each other for proper operation. The 2 DIP SWITCH bank on the RMT-4IR is located underneath the battery cover. The 4 DIP SWITCH bank for the 4x4 Component Matrix Over CAT-5 receiver is located on the underside of the unit beneath a black piece of metallic tape. DIP SWITCH 1 and 2 on the RMT-4IR correspond to *DIP SWITCH 1 and 2 on the 4x4 Component Matrix Over CAT-5 receiver.

NOTE: *DIP SWITCHES 3 and 4 are not used on the 4x4 Component Matrix Over CAT-5 receiver.



Remote

Remote Channel 1:
Default



Remote Channel 2:



Remote Channel 3:



Remote Channel 4:



4x4 Component Matrix Over CAT-5 receiver

Remote Channel 1:
Default



Remote Channel 2:



Remote Channel 3:

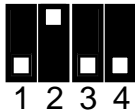

Remote Channel 4:



RS-232 SERIAL CONTROL INTERFACE



Only Pins 2 (RX), 3 (TX), and 5 (Ground) are used on the RS-232 serial interface

Binary Table

ASCII	Corresponding RMT16-IR Button	Binary	ASCII	Corresponding RMT16-IR Button	Binary
1	1	0011 0001	9	9	0011 1001
2	2	0011 0010	a	10	0110 0001
3	3	0011 0011	b	11	0110 0010
4	4	0011 0100	c	12	0110 0011
5	5	0011 0101	d	13	0110 0100
6	6	0011 0110	e	14	0110 0101
7	7	0011 0111	f	15	0110 0110
8	8	0011 1000	g	16	0110 0111

RS232 Settings

Bits per second 19200

Data bits 8

Parity None

Stop bits1

Flow Control None

NETWORK CABLE WIRING DIAGRAM

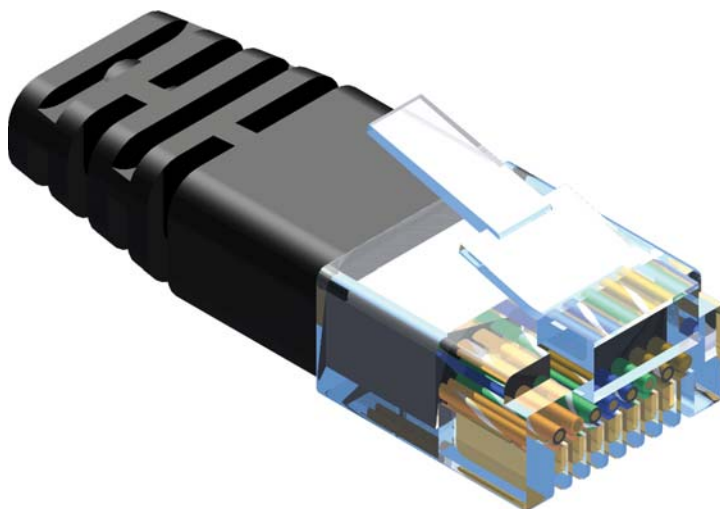

Gefen has specifically engineered their products to work with the TIA/EIA-568-B specification. Please adhere to the table below when field terminating cable for use with Gefen products. Failure to do so may produce unexpected results and reduced performance.

Pin	Color
1	Orange / White
2	Orange
3	Green / White
4	Blue
5	Blue / White
6	Green
7	Brown / White
8	Brown

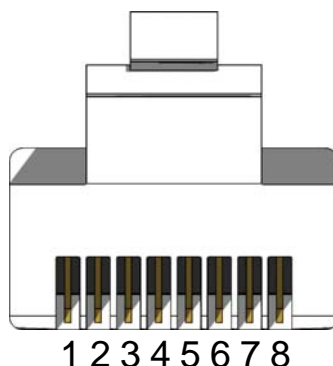

CAT-5, CAT-5e, and CAT-6 cabling comes in stranded and solid core types. Gefen recommends using solid core cabling. For this application, the use of CAT-5e cable is recommended for best results.

Each cable run must be one continuous run from one end to the other. No splices or use of punch down blocks.

RACK MOUNT INSTALLATION

Rack mount ears are provided for installation of this unit into a 1U rack mount space.

1. Locate the side screws on the unit.
2. Remove the front 2 screws that are located closest to the front of the unit.
3. Using the removed screws, screw the rack mounting bracket into the unit.
4. Repeat the procedure on the opposite side of the unit.



SPECIFICATIONS

Video Amplifier Bandwidth	350 MHz
Input Video Signal	1.2 volts p-p
Video Resolutions	1080p
Video Connector	RCA-style RGB x 3
Analog Audio Connector	RCA-style L + R (Stereo)
Digital Audio Connector	S/PDIF Coax. (Matrix), S/PDIF & Toslink (Receiver)
Link Connector	RJ-45 Shielded
Remote Control Port	RS232 female, mini-stereo
Power Supply Sender	24V DC (60 Watts) Receiver 5V DC (5 Watts)
Dimensions Sender	17"W x 3.5"H x 5.875"D
Dimensions Receiver	6.6"W x 1.3"H x 2.7"D
Shipping Weight	16 lbs