

S16MD01/S16MD02 S26MD01/S26MD02

8-Pin DIP Type SSR for Low Power Control

■ Features

1. Compact 8-pin dual-in-line package type
2. RMS ON-state current I_T : 0.6Arms
3. Built-in zero-cross circuit
(S16MD02 / S26MD02)
4. High repetitive peak OFF-state voltage
S16MD01 / S16MD02 V_{DRM} : MIN. 400V
S26MD01 / S26MD02 V_{DRM} : MIN. 600V
5. Isolation voltage between input and output
(V_{iso} : 4,000Vrms)
6. Recognized by UL, file No. E94758
7. Approved by CSA No. LR63705

■ Applications

1. Oil fan heaters
2. Microwave ovens
3. Refrigerators

■ Model Line-ups

	For 100V lines	For 200V lines
No built-in zero-cross circuit	S16MD01	S26MD01
Built-in zero-cross circuit	S16MD02	S26MD02

■ Outline Dimensions

(Unit : mm)

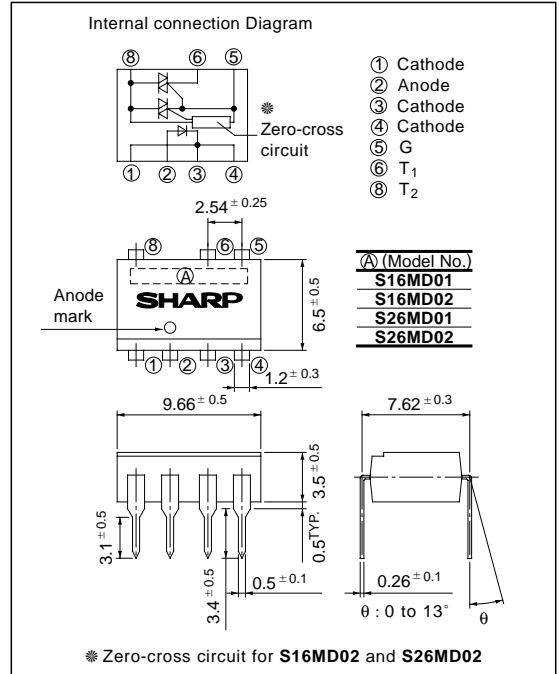

Terminal ①, ③ and ④ are common ones of cathode.
To radiate the heat, solder all of the lead pins on the pattern of PWB.

■ Absolute Maximum Ratings

(Ta = 25 °C)

Parameter		Symbol	Rating	Unit
Input	Forward current	I_F	50	mA
	Reverse voltage	V_R	6	V
Output	RMS ON-state current	I_T	0.6	A _{rms}
	*1 Peak one cycle surge current	I_{surge}	6	A
			V_{DRM}	400
Repetitive peak OFF-state voltage		600	V	
*2 Isolation voltage		V_{iso}	4 000	V _{rms}
Operating temperature		T_{opr}	- 25 to + 80	°C
Storage temperature		T_{stg}	- 40 to + 125	°C
*3 Soldering temperature		T_{sol}	260	°C

*1 50Hz sine wave

*2 AC for 1 minute, 40 to 60% RH, f = 60Hz

*3 For 10 seconds

Electrical Characteristics

(Ta = 25°C)

Parameter		Symbol	Conditions	MIN.	TYP.	MAX.	Unit
Input	Forward voltage	V _F	I _F = 20mA	-	1.2	1.4	V
	Reverse current	I _R	V _R = 3V	-	-	10	μA
Output	Repetitive peak OFF-state current	I _{DRM}	V _{DRM} = Rated	-	-	100	μA
	ON-state voltage	V _T	I _T = 0.6A	-	-	3.0	V
	Holding current	I _H	V _D = 6V	-	-	25	mA
	Critical rate of rise of OFF-state voltage	dV/dt	V _{DRM} = (1/√2) • Rated	100	-	-	V/μs
	Zero-cross voltage	V _{OX}	Resistance load I _F = 15mA	-	-	35	V
	S16MD02 S26MD02						
Transfer characteristics	Minimum trigger current	I _{FT}	V _D = 6V, R _L = 100Ω	-	-	10	mA
	Isolation resistance	R _{ISO}	DC500V, 40 to 60% RH	5 x 10 ¹⁰	10 ¹¹	-	Ω
	Turn-on time	t _{on}	V _D = 6V, R _L = 100Ω I _F = 20mA	-	-	100	μs
				S16MD01 S26MD01	-	-	50
	S16MD02 S26MD02						

Fig. 1 RMS ON-state Current vs. Ambient Temperature

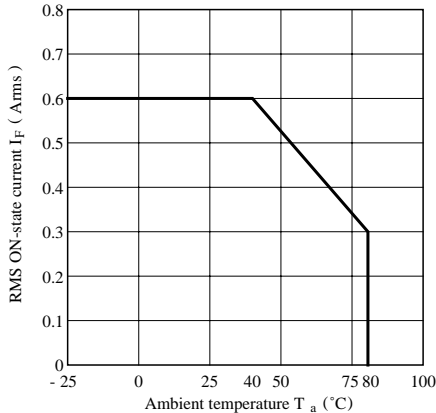

Fig. 2 Forward Current vs. Ambient Temperature

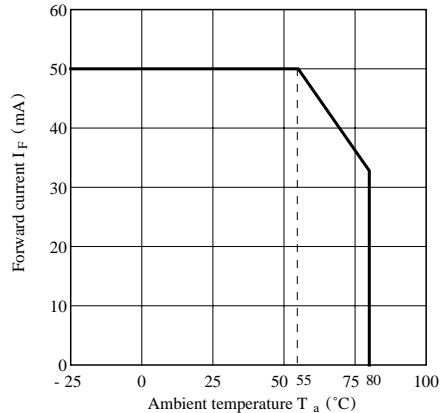

Fig. 3 Forward Current vs. Forward Voltage

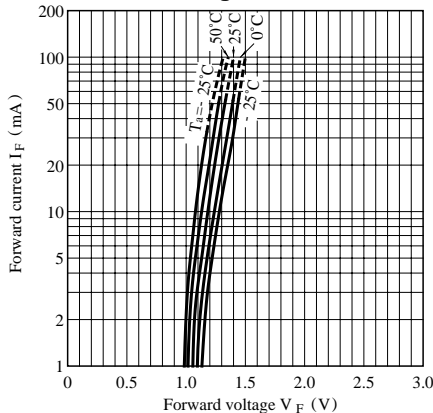

Fig. 4 Minimum Trigger Current vs. Ambient Temperature (S16MD01/S16MD02)

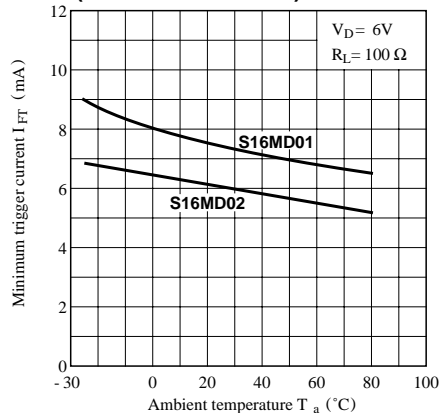

Fig. 5 Minimum Trigger Current vs. Ambient Temperature (S26MD01/ S26MD02)

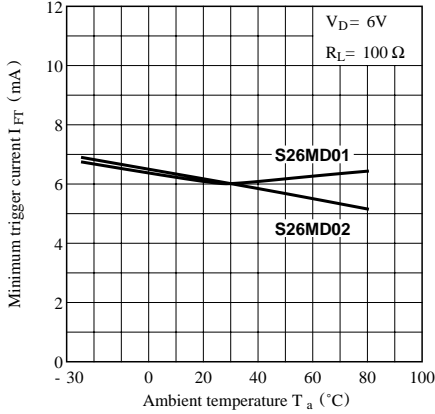

Fig. 6 ON-state Voltage vs. Ambient Temperature

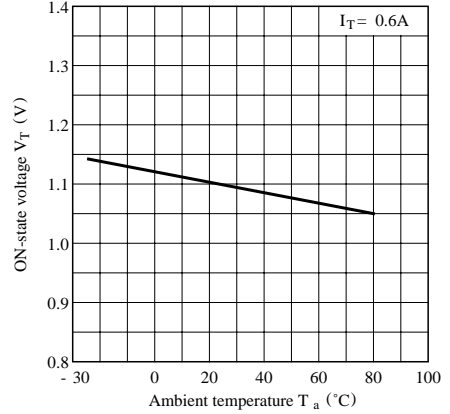

Fig. 7 Relative Holding Current vs. Ambient Temperature

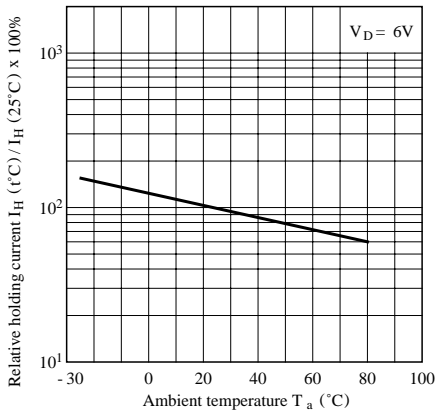

Fig. 8 ON-state Current vs. ON-state Voltage

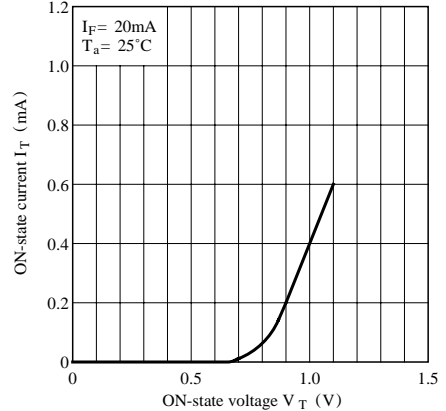

Fig. 9 Turn-on Time vs. Forward Current (S16MD01)

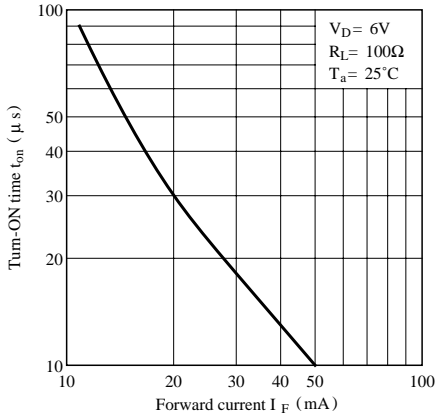

Fig.10 Turn-on Time vs. Forward Current (S26MD01)

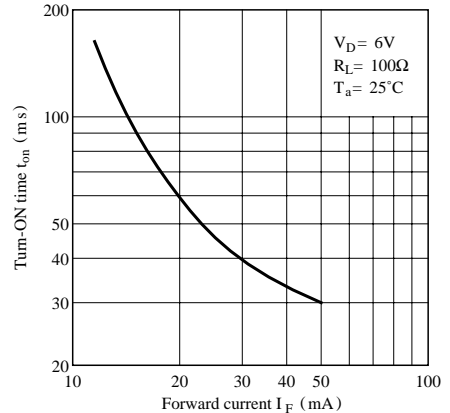

Fig.11 Turn-on Time vs. Forward Current
(S16MD02/S26MD02)

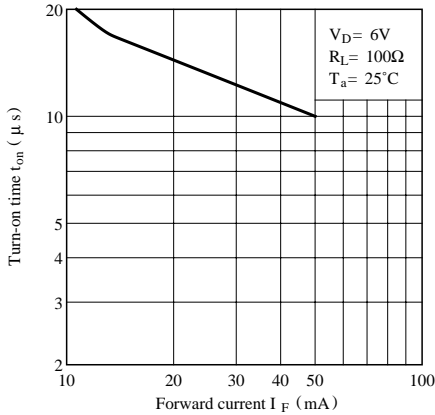
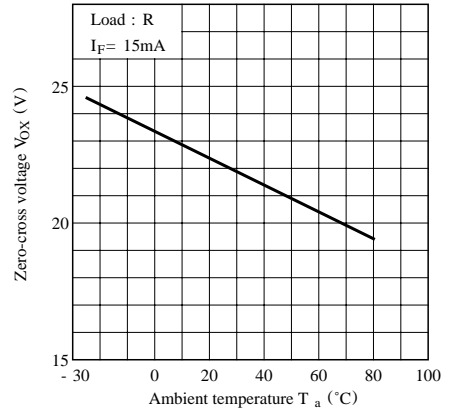
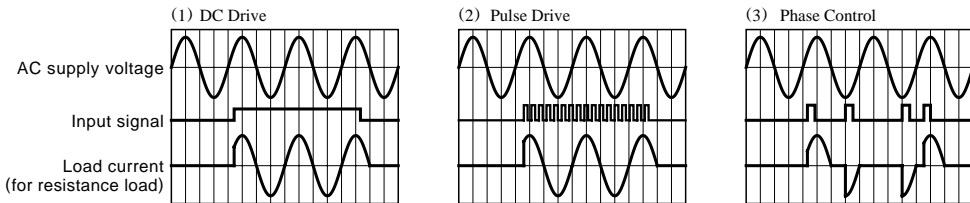
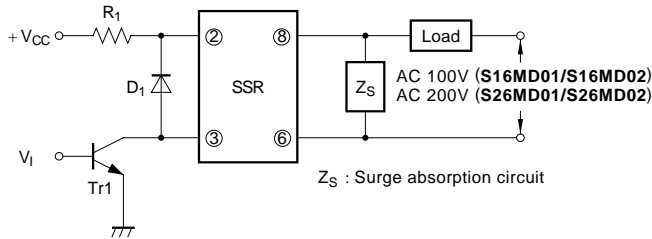

Fig.12 Zero-cross Voltage vs. Ambient Temperature
(S16MD02/S26MD02)



Basic Operation Circuit



- Notes 1) If large amount of surge is loaded onto V_{cc} or the driver circuit, add a diode D_1 between terminal 2 and 3 to prevent reverse bias from being applied to the infrared LED.
- 2) Be sure to install a surge absorption circuit.
An appropriate circuit must be chosen according to the load (for CR, choose its constant). This must be carefully done especially for an inductive load.
- 3) For phase control, adjust such that the load current immediately after the input signal is applied will be more than 30mA.

Precautions for Use

- All pins must be soldered since they are also used as heat sinks (heat radiation fins). In designing, consider the heat radiation from the mounted SSR.
- For higher radiation efficiency that allows wider thermal margin, secure a wider round pattern for Pin No.8 when designing mounting pattern. The rounded part of Pin No.5 (gate) must be as small as possible. Pulling the gate pattern around increases the change of being affected by external noise.
- As for other general cautions, refer to the chapter "Precautions for Use"

NOTICE

- The circuit application examples in this publication are provided to explain representative applications of SHARP devices and are not intended to guarantee any circuit design or license any intellectual property rights. SHARP takes no responsibility for any problems related to any intellectual property right of a third party resulting from the use of SHARP's devices.
- Contact SHARP in order to obtain the latest device specification sheets before using any SHARP device. SHARP reserves the right to make changes in the specifications, characteristics, data, materials, structure, and other contents described herein at any time without notice in order to improve design or reliability. Manufacturing locations are also subject to change without notice.
- Observe the following points when using any devices in this publication. SHARP takes no responsibility for damage caused by improper use of the devices which does not meet the conditions and absolute maximum ratings to be used specified in the relevant specification sheet nor meet the following conditions:
 - (i) The devices in this publication are designed for use in general electronic equipment designs such as:
 - Personal computers
 - Office automation equipment
 - Telecommunication equipment [terminal]
 - Test and measurement equipment
 - Industrial control
 - Audio visual equipment
 - Consumer electronics
 - (ii) Measures such as fail-safe function and redundant design should be taken to ensure reliability and safety when SHARP devices are used for or in connection with equipment that requires higher reliability such as:
 - Transportation control and safety equipment (i.e., aircraft, trains, automobiles, etc.)
 - Traffic signals
 - Gas leakage sensor breakers
 - Alarm equipment
 - Various safety devices, etc.
 - (iii) SHARP devices shall not be used for or in connection with equipment that requires an extremely high level of reliability and safety such as:
 - Space applications
 - Telecommunication equipment [trunk lines]
 - Nuclear power control equipment
 - Medical and other life support equipment (e.g., scuba).
- Contact a SHARP representative in advance when intending to use SHARP devices for any "specific" applications other than those recommended by SHARP or when it is unclear which category mentioned above controls the intended use.
- If the SHARP devices listed in this publication fall within the scope of strategic products described in the Foreign Exchange and Foreign Trade Control Law of Japan, it is necessary to obtain approval to export such SHARP devices.
- This publication is the proprietary product of SHARP and is copyrighted, with all rights reserved. Under the copyright laws, no part of this publication may be reproduced or transmitted in any form or by any means, electronic or mechanical, for any purpose, in whole or in part, without the express written permission of SHARP. Express written permission is also required before any use of this publication may be made by a third party.
- Contact and consult with a SHARP representative if there are any questions about the contents of this publication.