

Features

- Carbon element
- Ganging up to 8 sections available
- Knurled and flatted shaft styles
- Audio taper option
- Tracking error within 3 dB
- RoHS compliant*



PTR90 Series - 9 mm Multi-Ganged Potentiometer w/Rotary Switch

Electrical Characteristics

Standard Resistance Range 1 K ohms to 1 M ohms
 Total Resistance Tolerance ±10 % or ±20 %
 Standard Tapers Linear & audio taper
 Maximum Operating Voltage 150 VAC, 20 VDC
 Rated Power
 Linear Taper 0.05 watts
 Audio Taper 0.025 watts
 Noise 100 mV max.
 Insulation Resistance @ 250 VDC 100 M ohms
 Dielectric Withstanding Voltage 300 VAC
 End Resistance 20 ohms max.
 Tracking Error (-40 dB to 0 dB) ±3 dB

Environmental Characteristics

Operating Temperature -10 °C to +50 °C
 Rotational Life 10,000 cycles
 IP Rating IP 40

Switch Characteristics

Contact Resistance 50 milliohms max.
 Rated Power 3 A @ 16 VDC
 Detent Torque 400 g-cm max.
 Switch Activation Angle 50 ° max.

Mechanical Characteristics

Mechanical Angle 300 ° ±10 °
 Running Torque 10 to 250 g-cm
 Stop Strength 4.0 kg-cm
 Shaft Push/Pull Strength 5.0 kgf min.
 Shaft Wobble 0.6 x L/20 mm p-p max.
 Mounting Torque 7.0 kg-cm min.
 Soldering Condition
 Manual Soldering
 96.5 Sn/3.0 Ag/0.5 Cu solid wire
 or no-clean rosin cored wire
 270 °C max. for 3 seconds
 Wave Soldering
 96.5 Sn/3.0 Ag/0.5 Cu solder
 with no-clean flux
 260 °C max. for 5 seconds
 Wash Process Not recommended
 Mounting Hardware One flat washer
 and one mounting nut supplied
 per potentiometer

Product Dimensions

PTR901

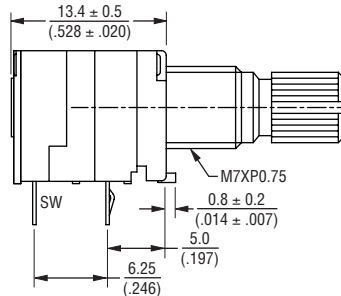

RECOMMENDED PCB LAYOUT

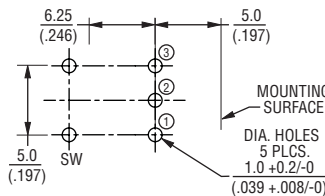

SCHEMATIC

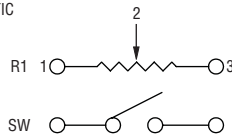

PTR902

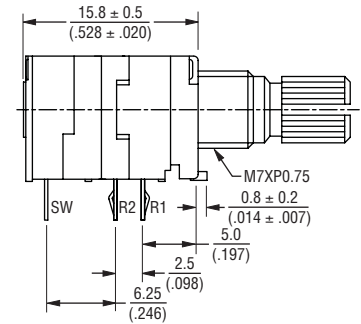

RECOMMENDED PCB LAYOUT

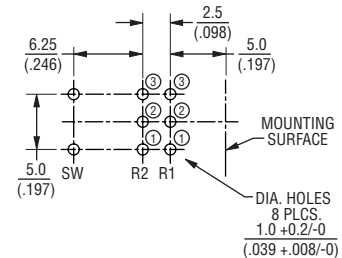

SCHEMATIC

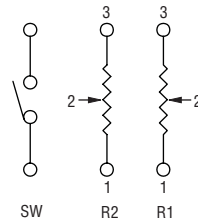

DIMENSIONS: $\frac{\text{MM}}{\text{(INCHES)}}$

*RoHS Directive 2002/95/EC Jan 27 2003 including Annex Specifications are subject to change without notice. Customers should verify actual device performance in their specific applications.

Applications

- Audio/TV sets
- Automotive sound systems
- Amplifiers/mixers/drum machines/synthesizers/DJ equipment
- Multimedia sound systems
- Portable electronics

PTR90 Series - 9 mm Multi-Ganged Potentiometer w/Rotary Switch

BOURNS®

Product Dimensions

PTR904

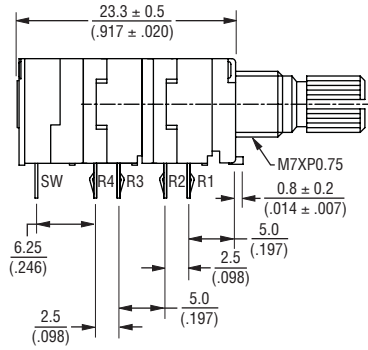

RECOMMENDED PCB LAYOUT

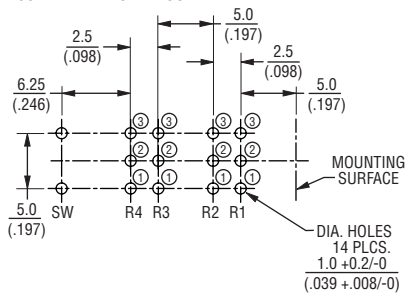

SCHEMATIC

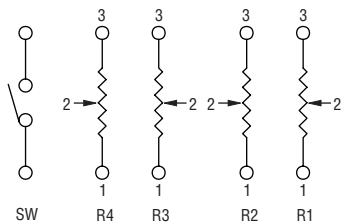

DIMENSIONS: $\frac{\text{MM}}{\text{(INCHES)}}$

PTR906

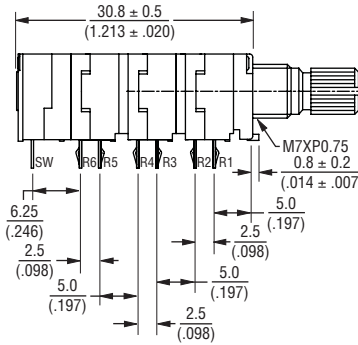

RECOMMENDED PCB LAYOUT

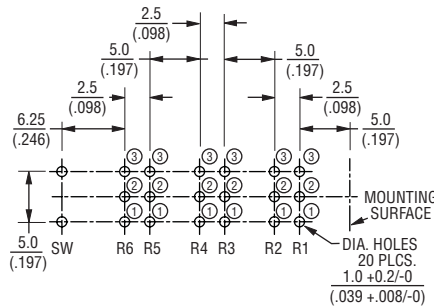

SCHEMATIC

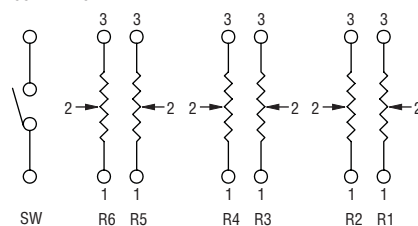

PTR908

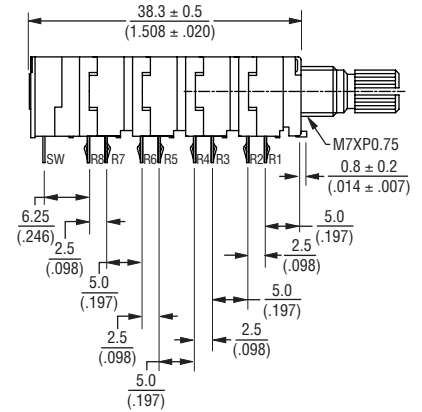

RECOMMENDED PCB LAYOUT

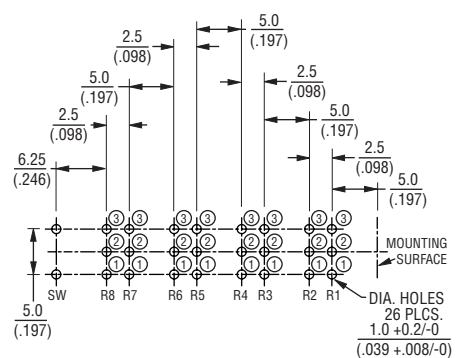

SCHEMATIC

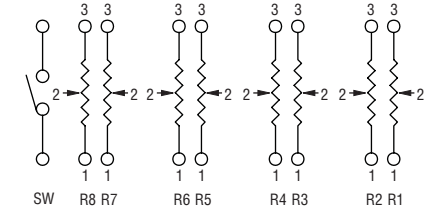

PTR90 Series - 9 mm Multi-Ganged Potentiometer w/Rotary Switch



Product Dimensions

SHAFT STYLE "K"

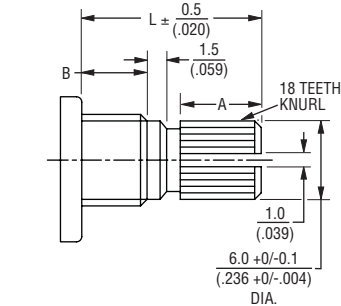

SHAFT SHOWN IN CCW POSITION

L	15 (.591)	20 (.787)	25 (.984)
B	5 (.197)	7 (.276)	10 (.394)
A	6 (.236)	10 (.394)	12 (.472)

DIMENSIONS: $\frac{\text{MM}}{\text{(INCHES)}}$

SHAFT STYLE "F"

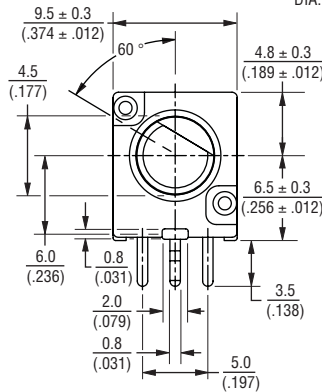
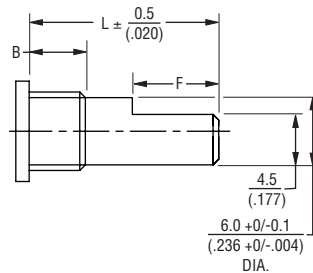

SHAFT SHOWN IN CCW POSITION

L	15 (.591)	20 (.787)	25 (.984)
B	5 (.197)	7 (.276)	10 (.394)
F	7 (.276)	12 (.472)	12 (.472)

Derating Curve

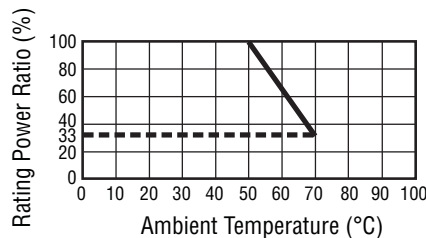

How To Order

PTR90 1 - 2 0 20 K - B 203

Model

- PTR90 = With Rotary Switch

No. of Sections

- 1 = 1 Section
- 2 = 2 Sections
- 3 = 3 Sections
- 4 = 4 Sections
- 5 = 5 Sections
- 6 = 6 Sections
- 8 = 8 Sections

Pin Style

- 1 = PC Pins vertical/down facing and ±10 % Total Resistance Tolerance
- 2 = PC Pins vertical/down facing and ±20 % Total Resistance Tolerance

Center Detent Option

- 0 = No Detent
- 2 = Center Detent

Standard Shaft Length

- 15 = 15 mm
- 20 = 20 mm
- 25 = 25 mm

Shaft Styles

- K = Knurled Type Shaft (Metal)
- 18 Toothed Serration Type
- F = Flatted Metal Shaft

Resistance Taper

- A = Audio Taper
- B = Linear Taper

Resistance Code (See Table)

Other taper and shaft styles available.

Standard Resistance Table

Resistance (Ohms)	Resistance Code
1,000	102
2,000	202
5,000	502
10,000	103
20,000	203
50,000	503
100,000	104
200,000	204
500,000	504
1,000,000	105