

PSA / PSB Series

Digital, High accuracy pressure control in small size

Features

- High accuracy semi conductor pressure sensor
- High brightness red LED(LED height:9.5mm)
- High resolution : 1/1000
- Convertible pressure unit
Vacuum pressure, Compound pressure :
kPa, kgf/cm², bar, psi, mmHg, mmH₂O, inHg
Positive pressure : kPa, kgf/cm², bar, psi
- Various output modes :
Hysteresis mode, Automatic sensitivity setting mode,
Individual 2 output mode, Window comparative output mode
- Chattering prevention function of output
(Selectable response time : 2.5, 5, 100, 500ms)
- Analog output (1-5VDC)
- Current protection circuit, Reverse power polarity protecting circuit
- Zero point adjustment function
- Display function of the Peak and Bottom hold



! Please read "Caution for your safety" in operation manual before using.



Ordering information

PSA - V 01 P

Series	Appearance	Pressure sort	Pressure range	Output type		NPN open collector output
					P	PNP open collector output
					01	100kPa
					1	1MPa
						Standard pressure type
					V	Vacuum pressure type
					C	Compound pressure type
					A	Regular square(30mm×30mm)
					B	Rectangular(10.2mm×54mm)
					PS	Pressure Sensor

Pressure and Max. pressure display range

Type	kPa	kgf/cm ²	bar	psi	mmHg	inHg	mmH ₂ O
Vacuum pressure	0 ~ -101.3 (5.0 ~ -101.3)	0 ~ -1.034 (0.051 ~ -1.034)	0 ~ -1.034 (0.05 ~ -1.034)	0 ~ -14.70 (0.72 ~ -14.70)	0 ~ -760 (38 ~ -760)	0 ~ -29.9 (1.5 ~ 29.9)	0 ~ -103.4 (5.1 ~ 103.4)
Standard pressure	0 ~ 100.0 (-5.0 ~ 110.0)	0 ~ 1.020 (-0.051 ~ 1.122)	0 ~ 1.020 (-0.050 ~ 1.100)	0 ~ 14.50 (-0.72 ~ 15.90)	-	-	-
	0 ~ 1000 (-50 ~ 1013)	0 ~ 10.20 (-0.51 ~ 11.22)	0 ~ 10.20 (-0.50 ~ 11.00)	0 ~ 145.0 (-7.2 ~ 159.0)	-	-	-

※ () is Max. pressure display range.

※ When using a unit mmH₂O, please multiply display value by 100.

Pressure conversion chart

From \ To	Pa	kPa	MPa	kgf/cm ²	mmHg	mmH ₂ O	psi	bar	inHg
1kPa	1000.000	1	0.001000	0.010197	7.500616	101.9689	0.145038	0.010000	0.2953
1kgf/cm ²	98069.10	98.06910	0.098069	1	735.5787	10000.20	14.22334	0.980691	28.95979
1mmHg	133.3220	0.133322	0.000133	0.001359	1	13.5954	0.019336	0.001333	0.039370
1mmH ₂ O	9.80665	0.00980	-	0.000099	0.0735578	1	0.00142	0.000098	0.002895
1psi	6894.939	6.89493	0.00689	0.070307	51.71630	703.07	1	0.068947	2.036074
1Pa	100000.0	100.0000	0.100000	1.019689	750.062	10196.89	14.50339	1	29.52998
1inHg	3386.388	3.386388	0.003386	0.034530	25.40000	345.3240	0.491141	0.033863	1

Ex) When need to calculate 760mmHg as Pa unit.

: According to above chart, 1mmHg is 0.133322kPa, therefore 760mmHg will be 760×0.133322kPa=101.32472kPa.

Pressure Sensor

Specifications

Pressure type		Gauge pressure			
		Vacuum pressure type	Standard pressure type		Compound pressure type
Model	NPN output	PSA-V01 PSB-V01	PSA-01 PSB-01	PSA-1 PSB-1	PSA-C01 PSB-C01
	PNP output	PSA-V01P PSB-V01P	PSA-01P PSB-01P	PSA-1P PSB-1P	PSA-C01P PSB-C01P
Rated pressure range		0.0~101.3kPa	0~100.0kPa	0~1,000kPa	-100.0~100kPa
Display and set pressure range		5.0~101.3kPa	-5.0~110.0kPa	-50~1,100kPa	-101.3~110kPa
Max. pressure range		2 times of rated pressure		1.5 times of rated pressure	2 times of rated pressure
Applicable fluid		Air, Non-corrosive gas			
Power supply		12V~24VDC ±10% (Ripple P-P:Max. 10%)			
Current consumption		Max. 50mA			
Control output		<ul style="list-style-type: none"> NPN open collector output ⇨ Load current : Max. 100mA, Load voltage : Max. 30VDC, Residual voltage : Max. 1V PNP open collector output ⇨ Max. sink current : Max. 100mA, Residual voltage : Max. 2V 			
Hysteresis (*1)		1digit (2digit/psi) fixed		2digits fixed	
Repeat error		±0.2% F.S. ±1digit		±0.2% F.S. ±2digits	
Response time		Selectable 2.5ms, 5ms, 100ms, 500ms			
Short circuit protection		Built-in			
Analog output		<ul style="list-style-type: none"> Output voltage : 1~5VDC ±2% F.S. Zero point: Within 1VDC ±2% F.S. Span: Within 4VDC ±2% F.S. Linear : Within ±2% F.S. Resolution : Approx. 1/200 Output impedance : 1kΩ 			
Display method		3½ digit LED 7Segment			
Min. display interval		1digit (2digit/psi)		2digits	
Pressure unit		kPa, kgf/cm ² , bar, psi, mmHg, mmH ₂ O, inHg	kPa, kgf/cm ² , bar, psi		kPa, kgf/cm ² , bar, psi, mmHg, mmH ₂ O, inHg
Characteristic of control output and displayed temp.		(*2) Max. ±1% F.S.		Max. ±2% F.S.	
Analog output temperature characteristic		Max. ±2% F.S. (at 25°C)			
Environment	Ambient temperature	-10°C ~ +50°C (at non-freezing status)			
	Storage temperature	-20°C ~ +60°C (at non-freezing status)			
	Ambient humidity	35 ~ 85%RH			
	Storage humidity	35 ~ 85%RH			
	Vibration	1.5mm amplitude at frequency of 10 ~ 55Hz in each of X, Y, Z directions for 2 hours			
Material		<ul style="list-style-type: none"> PSA ⇨ Front case : PC, Rear case : PC (Insert glass), Pressure port : die-cast (Zn) PSB ⇨ Case, Pressure port : PA 			
Protection		IP40 (IEC specification)			
Cable		∅4mm, 5P, Length : 2m			
Approval		CE			
Weight		PSA : Approx. 120g, PSB : Approx. 70g			

*F.S. (Full Scale) : Specified pressure range.

*Pressure port : • PSA type → Standard NPT1/8 (Color:Black), Option Rc (PT)1/8 (Color:Silver) • PSB type → M5

*(*1) The Hysteresis is changeable in output operation of F-1 mode.

*(*2) Max. ±1% at 25°C.

● Analog output voltage-Pressure characteristic

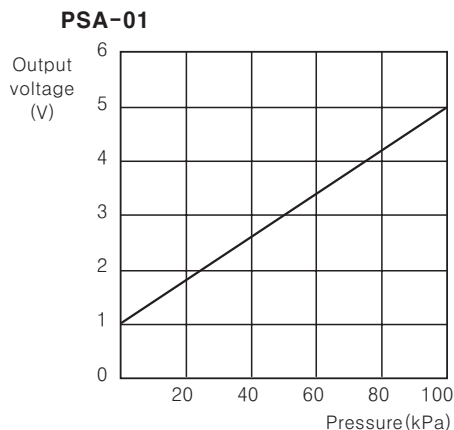

● Analog output voltage linear

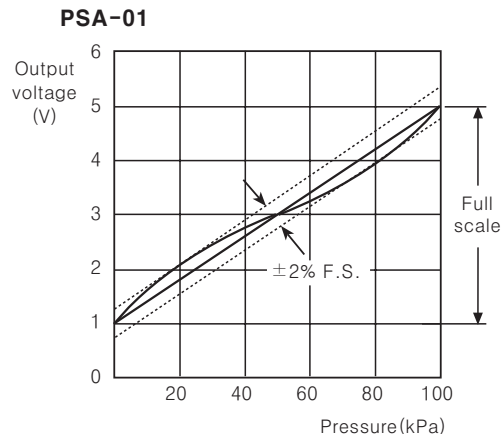

(A) Counter

(B) Timer

(C) Temp. controller

(D) Power controller

(E) Panel meter

(F) Tacho/Speed/Pulse meter

(G) Display unit

(H) Sensor controller

(I) Proximity sensor

(J) Photo electric sensor

(K) Pressure sensor

(L) Rotary encoder

(M) 5-Phase stepping motor & Driver & Controller

PSA / PSB Series

■ Dimensions

Unit:mm

●PSA

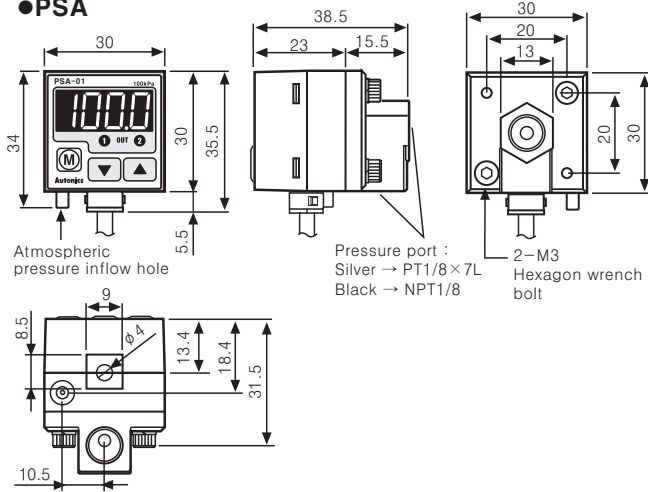

●PSB

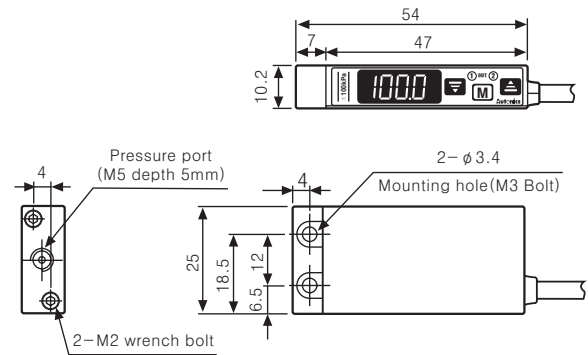

●Fixing bracket for mounting(PSA type)

<Bracket A >

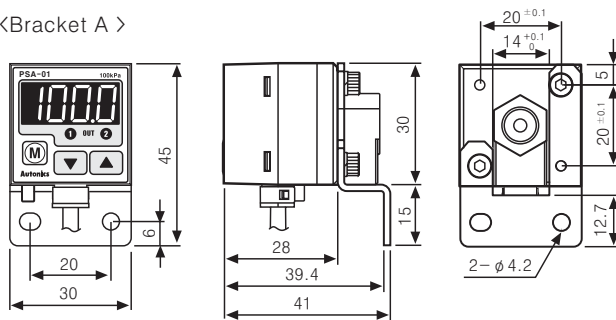

<Bracket B >

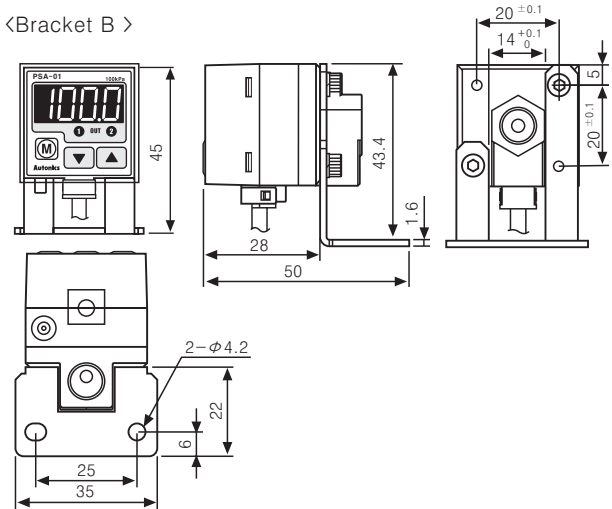

●Bracket for mounting (PSA type)

●Accessory

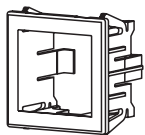

< PSO-01 >

●Accessory

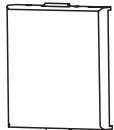

< PSO-02 >

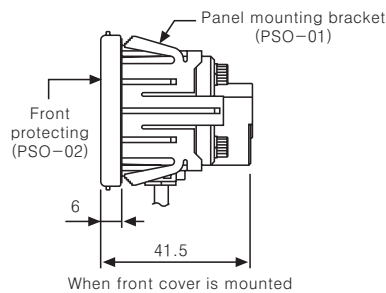
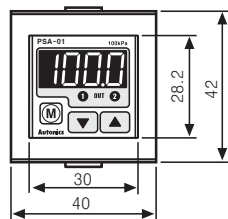

●Panel cut-out

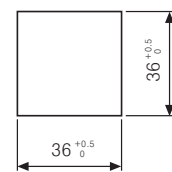

●Bracket-A

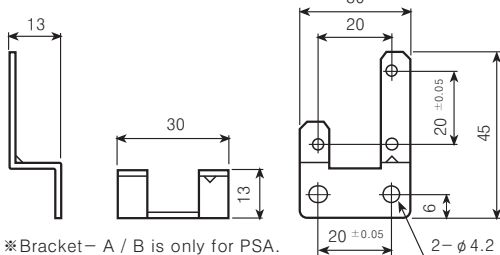

※Bracket-A / B is only for PSA.

●Bracket-B

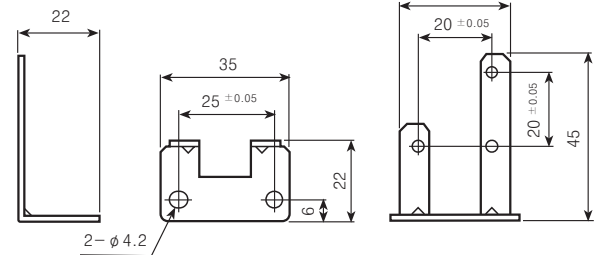

Pressure Sensor

Control output diagram(PSA/PSB)

●NPN open collector output

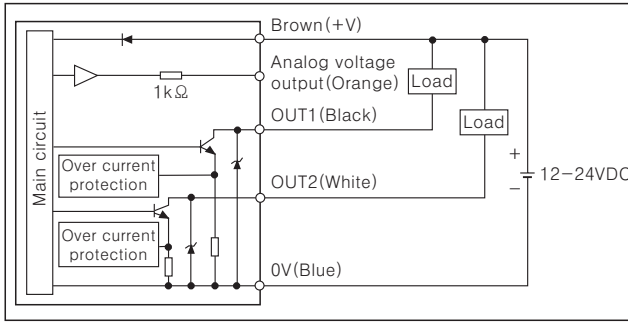

●PNP open collector output

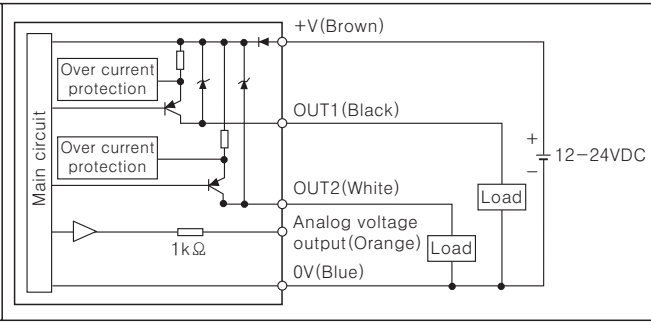

※ There is no short-circuit protection in analog voltage output. Do not connect this output to power source or capacitive load directly.
 ※ Please observe input impedance of connected equipment when use analog voltage output.
 And be sure to check voltage drop caused by resistance of extended wire.

Front panel identification

(PSA Type)

(PSB Type)

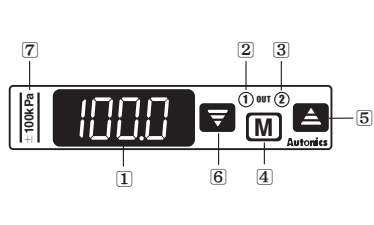
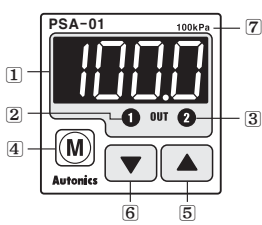

- ④ **Mode key** : Parameter setting mode or preset setting mode, save setting value
- ⑤ **Up key** : Set the setting value to lower step in preset setting or pressure unit, output mode, response time, analog output scale, key lock, peak hold value, bottom hold value display in parameter setting
- ⑥ **Down key** : Set setting value to upper step in preset setting or pressure unit, output mode, response time, analog output scale, key lock, peak hold, bottom hold display in parameter setting
- ⑦ **Range of rating pressure** : It is possible to change the pressure unit in PSA series. Please use different unit as label for your application.

- ① **3 1/2 LED display (Red)** : Display detected pressure, every setting value and display error
- ② **1 output indicator (Red)** : Output 1 is ON, LED will be ON
- ③ **2 output indicator (PSA:Red, PSB:Green)** : Output 2 is ON, LED will be ON

Setting(PSA/PSB)

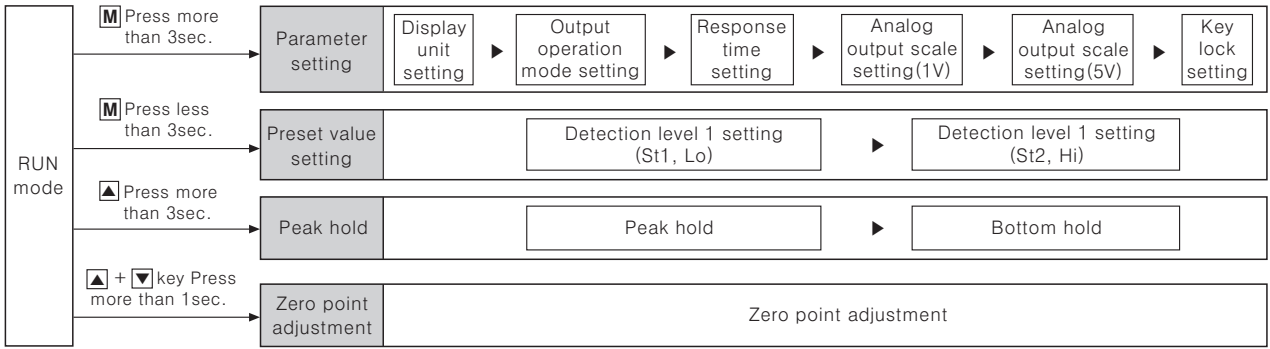

Operations(All models are the same)

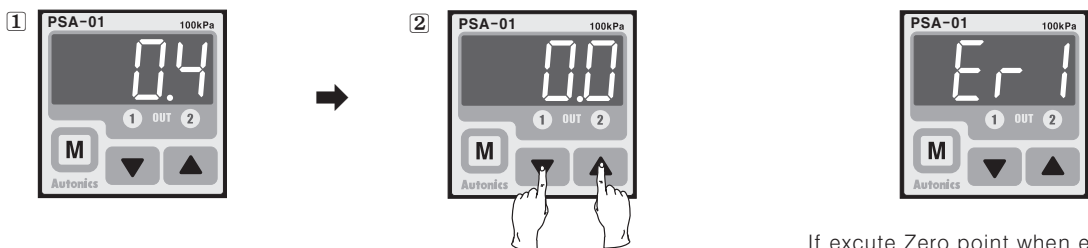

1. In state of atmospheric pressure during RUN mode, press **▼** key and **▲** key at the same time for over 1sec.
 2. When the zero point adjustment is completed, it will display **0.0** and return to RUN mode automatically.
- ※ Please execute Zero point adjustment regularly.

If excute Zero point when external pressure has been applied, **Er 1** will be flashing. Please execute Zero point again in state of atmospheric pressure.

- (A) Counter
- (B) Timer
- (C) Temp. controller
- (D) Power controller
- (E) Panel meter
- (F) Tacho/Speed/Pulse meter
- (G) Display unit
- (H) Sensor controller
- (I) Proximity sensor
- (J) Photo electric sensor
- (K) Pressure sensor
- (L) Rotary encoder
- (M) 5-Phase stepping motor & Driver & Controller

PSA / PSB Series

Setting parameter(PSA/PSB)

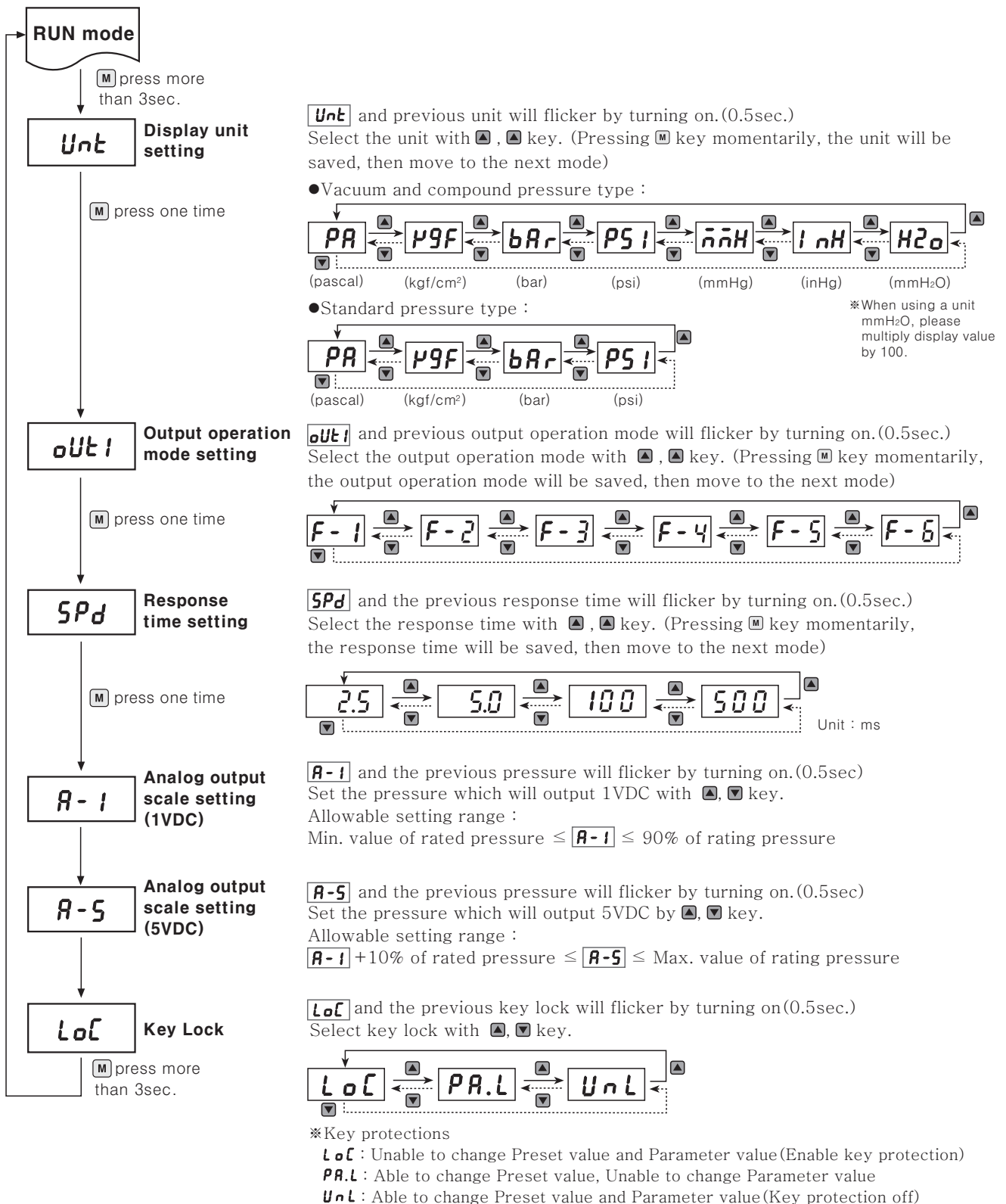

- ※ When entering into Parameter setting mode and preset setting mode, it displays "Setting item" and "Previous setting value" by 0.5 sec. turn. This display will stop by pressing \blacktriangledown or \blacktriangleleft key (Display setting value), if no key touched for over 1 sec., it will display old value by 0.5sec. turn again.
- ※ When pushing \blacksquare Key for 3sec. during setting, it will return to RUN mode with memorizing on EEPROM. However, when there is no key input for 60sec., it turns to RUN mode with keeping the previous setting value not current setting value.
- ※ There is memory retention by EEPROM, but life cycle of EEPROM is 100,000 times.

Pressure Sensor

■ Preset value setting(PSA/PSB)

● Hysteresis mode(F-1) and 2 independent(F-3, F-4, F-5) output mode

Press **M** Key in Run mode.

Press **M** Key in Run mode.

Press **M** Key in Run mode.

Display alternates by 0.5sec.

Set the pressure detection level 1 by **▲**, **▼** key.
Allowable setting range :
Min. value of setting pressure < St1 ≤ Max. value of setting pressure

Display alternates by 0.5sec.

Select the pressure detection level 2 by **▲**, **▼** key.
Allowable setting range :
• Hysteresis mode : Min. value of setting pressure ≤ St2 < St1
• 2 independent output mode : Min. value of setting pressure < St2 ≤ Max. value of setting pressure

● Automatic sensitivity setting mode(F-2)

Press **M** key in Run mode.

Press **M** key in Run mode.

Press **M** key in Run mode.

Press **M** key in Run mode.

Display alternates by 0.5sec.

After applying St1 in to Pressure port, then press **▲** Key. (Able to set repeatedly by **▲** Key)

Display alternates by 0.5sec.

After applying St2 in to Pressure port, then press **▲** Key.

Display alternates by 0.5sec.

SET value will be calculated automatically and fine adjustment is available between St1 and St2 by **▲**, **▼** Key.

Setting range :
St1 + 1% of rated pressure ≤ St2 ≤ Max. rated pressure

$$SET = \frac{St1 + St2}{2}$$

Adjustable range of set value : Between St1 and St2.

● Window mode(F-6)

Press **M** key in Run mode.

Press **M** key in Run mode.

Press **M** key in Run mode.

Display alternates by 0.5sec.

Set Low setting value by **▲**, **▼** Key.
Allowable setting range :
Min. setting pressure ≤ Lo < Max. value of setting pressure

Display alternates by 0.5sec.

Set High setting value by **▲**, **▼** Key.
Allowable setting range :
Lo < Hi ≤ Max. value of setting pressure

- If no key touched for 60sec., it will return to RUN mode. [Automatic sensitivity setting mode(F-2) is exception]
- When changing the display unit, preset value will be calculated according to the display unit.
- Whenever key touched one time, 2digits increased(decreased) but it will be continuously increasing(decreasing) by pressing **▲**, **▼** key constantly.

■ Peak Hold and Bottom Hold

1. Press **▲** for more than 3sec. in RUN mode.
 2. **PEH** and memorized max. pressure(Negative type is for max. vacuum pressure) will flicker by turning on (0.5sec.) then display Peak hold value.
 3. **boH** and memorized min. pressure(Negative type is for min. vacuum pressure) will flicker by turning on (0.5sec.) then display Bottom hold value.
 4. If press **▲** key one time shortly, memorized Peak hold and Bottom hold value will be removed then return to RUN mode.
- ※ When the Peak hold and Bottom hold value is over the max. display pressure value, it displays **HHH**. On the opposite, it displays **LLL**. Please remove Peak hold and Bottom hold value by using **▲** key.

(A) Counter

(B) Timer

(C) Temp. controller

(D) Power controller

(E) Panel meter

(F) Tacho/Speed/Pulse meter

(G) Display unit

(H) Sensor controller

(I) Proximity sensor

(J) Photo electric sensor

(K) Pressure sensor

(L) Rotary encoder

(M) 5-Phase stepping motor & Driver & Controller

PSA / PSB Series

■ Output operation mode(PSA/PSB)

1. Hysteresis mode(F-1)

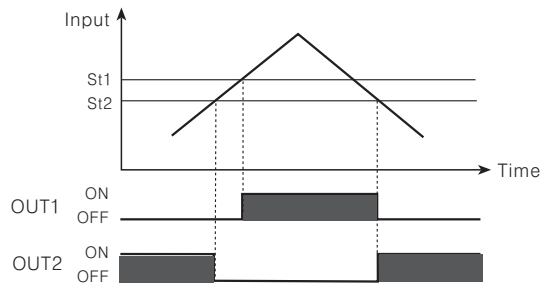

※It can be set for pressure detection level(St1) and detection difference(St2).

※St1 setting range : Min. value of specified pressure ≤ St1 ≤ Max. value of specified pressure

St2 setting range : Min. value of specified pressure ≤ St2 ≤ St1

- OUT 1 : When applying pressure is larger than St1, it will be ON.
- OUT 2 : When applying pressure is lower than St2, it will be ON.

2. Automatic sensitivity setting mode(F-2)

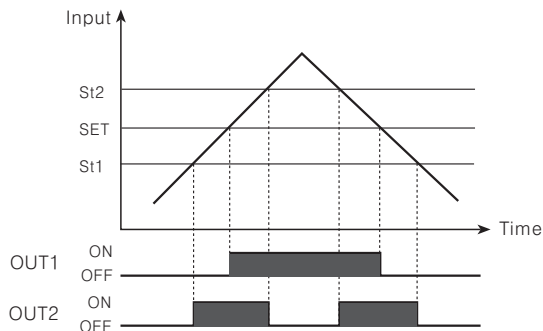

※This function is to set pressure detection level to the proper position automatically, it is set by received pressure from two position(St1, St2).

※The hysteresis fixed to 1 digit(psi unit and compound type 2digits)

※SET value will be calculated as below.

$$\text{SET setting value} = \frac{(\text{St1 setting value} + \text{St2 setting value})}{2}$$

- OUT 1: When applying pressure is larger than SET value, it will be ON.
- OUT 2: When applying pressure is between St1 and St2, it will be ON.

Note1) If there is not enough difference of detecting level between St1 and St2, **Er3** will be displayed.

Please set again after applying enough pressure.

Note2) When need fine adjustment for detection level, adjust detection level(SET) by , key.

(Adjustment range : Between St1 and St2)

3. Independent 2 output mode(F-3, F-4, F-5)

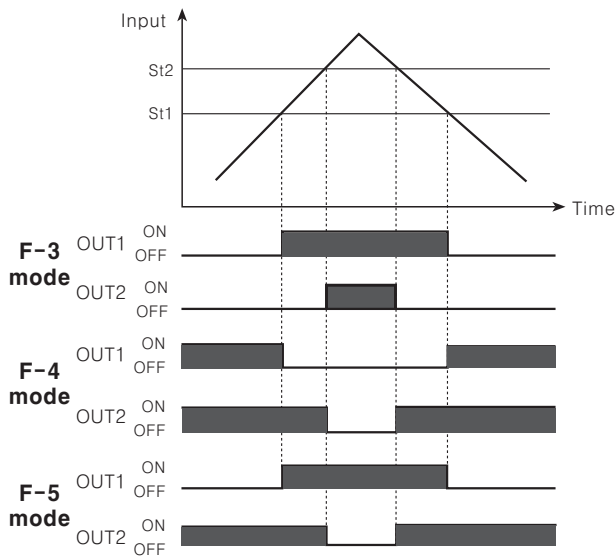

※St1 and St2 can be set independently within specified pressure range.

One is for control, the other is for alarm or optional control.

※The hysteresis fixed to 1 digit(psi unit and compound type 2 digits)

※St1 setting range : Min. value of specified pressure ≤ St1 ≤ Max. value of specified pressure

St2 setting range : Min. value of specified pressure ≤ St2 ≤ Max. value of specified pressure

●Independent 2 output mode(F-3)

- OUT 1 : It will be ON, when it is beyond St1.
- OUT 2 : It will be ON, when it is beyond St2.

●Independent 2 opposite mode(F-4)

- OUT 1 : It will be OFF when it is beyond St1.
- OUT 2 : It will be OFF, when it is beyond St2.

●Independent 2 cross mode(F-5)

- OUT 1 : It will be OFF when it is under St1.
- OUT 2 : It will be ON, when it is under St2.

4. Window mode(F-6)

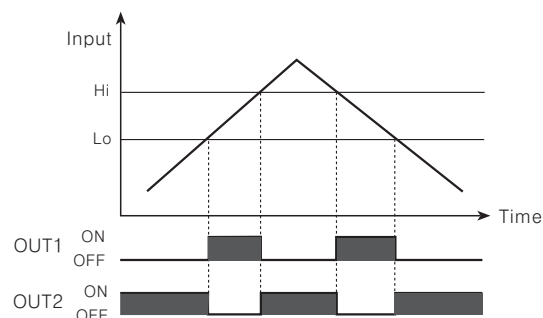

※It is able to set Lo/Hi-limit value of pressure detection level in this mode.

※The hysteresis fixed to 1 digit(psi unit and compound type 2 digits)

※Lo setting range : Min. value of specified pressure ≤ Lo ≤ Max. value of specified pressure

Hi setting range : Lo < Hi ≤ Max. value of specified pressure

- OUT 1 : It will be ON between High limit value(Hi) and Low limit value (Lo)
- OUT 2 : It will be ON when it is beyond High limit value(Hi) and Low limit value(Lo).

■ Function(PSA/PSB)

1. Change of display unit

PS□-V01 has 7 kinds of pressure unit and PS□-01 and PS□-1 has 4 kinds of pressure unit. Please select the proper unit for application.

- PS□-V01, PS□-C01 : kPa, kgf/cm², bar, psi, mmHg, inHg, mmH₂O
- PS□-01, PS□-1 : kPa, kgf/cm², bar, psi

2. Change of output mode

There are 6 kinds of control output modes in order to provide the various pressure detection. Select a mode for your proper application.

- Hysteresis mode (F-1) :
When you need variable hysteresis for detecting pressure.
- Automatic sensitivity setting mode (F-2) :
When you need to set detection sensitivity automatically at proper position.
- Independent 2 output mode (F-3, F-4, F-5) :
When you need to detect pressure from two position with one product.
- Window output mode (F-6) :
When you need to detect pressure in a certain range.

3. Change of response time(Chattering prevention)

It can prevent chattering of control output by changing response time. You are able to set 4 kinds of response time (2.5ms, 5ms, 100ms, 500ms) and if the response is getting longer, the detection will be more stable by increasing the number of digital filter.

4. Change of Analog output scale

It is not only used to set the analog output (1-5VDC) scale for a rated pressure range, but also can be used to change the range for proper user's application. Setting A1 position for 1VDC output and A2 position for 5VDC output. Therefore analog output will be 1-5VDC between A1 and A2.

5. Key lock function

This unit has 2 kinds of keys lock function in order to prevent wrong operation.

- **Loc** : In this status all keys are locked therefore it is impossible to change any parameter setting /preset, Zero point adjustment, Peak hold and Bottom hold.
- **PA.L** : This is partial locked status, therefore it is impossible to change parameter setting, (Able to change the status of lock) only, the other functions can be changed.
- **UnL** : This status, all keys are unlocked.

6. Zero point adjustment function

This function is to set the display value of pressure at zero when port is opened to atmospheric pressure.

7. Peak hold and Bottom hold function

This function is diagnosis malfunction of the system caused by parasitic pressure or to check through memorizing the max./min. pressure that occurred in the system.

8. Error

Error display	Problem	Remedy
	If external pressure applied, when adjusting Zero point	Please try again after external pressure removing
	When overloaded on control output	Remove overload
	When the setting value is not matched with setting condition	Set proper setting value after checking setting condition
	When the applied pressure exceeds the upper display pressure range up	Apply pressure within display pressure range
	When the applied pressure exceeds the lower display pressure range down	

■ Installation(PSA)

1. When installing pressure port it is able to bring pressure from 3 directions by changing the mounting direction of the pressure port.
2. Basic spec of pressure port is NPT 1/8(Color:Black). [Option:PT 1/8(Color:Silver)] It is able to use general one touch fitting.
3. Please use seal tape at port plug in order to prevent pressure leak.
4. Please block another two pressure ports not used with port plug.
5. Please connect it by using spanner(13mm) at the metal part in order not to overload on the body when connecting one touch fitting.

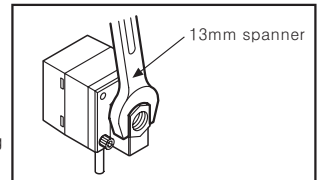
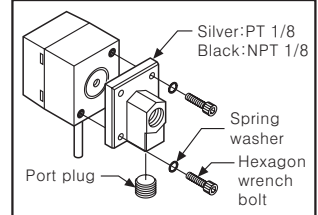
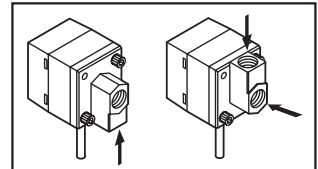

⚠ Caution

The tightening torque of one touch fitting should be max. 10N · m. It may cause mechanical trouble.

6. PSA series has 2 kinds of brackets so it is able to install it in two different ways.
7. At first, please unscrew hexagon wrench bolt and assemble the bracket on this unit by fixing the hexagon wrench bolt.

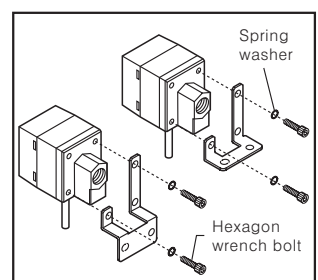

In this case, tightening torque of hexagon wrench should be max. 3N · m. It may cause mechanical trouble.

8. Bracket(PSO-01) and front protection cover(PSO-02) are optional to sell. Please see the pictures for installation.

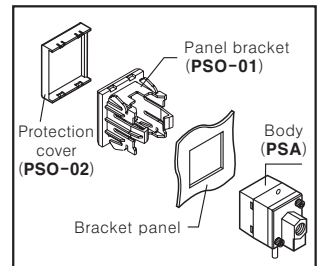

(A) Counter

(B) Timer

(C) Temp. controller

(D) Power controller

(E) Panel meter

(F) Tacho/Speed/Pulse meter

(G) Display unit

(H) Sensor controller

(I) Proximity sensor

(J) Photo electric sensor

(K) Pressure sensor

(L) Rotary encoder

(M) 5-Phase stepping motor & Driver & Controller

PSA / PSB Series

Installation(PSB)

1. Pressure port is M5.
It is able to use general one touch fitting.
2. It is able to use it without the pressure port according to environment. In this case O-Ring between pressure port and its body should not be taken out in order not to prevent pressure leak.
3. Please connect it by using spanner(10mm) at pressure port in order not to overload on the body when connecting one touch fitting.

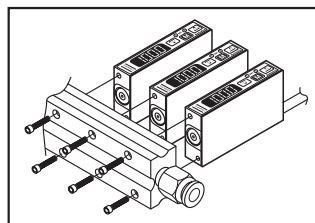
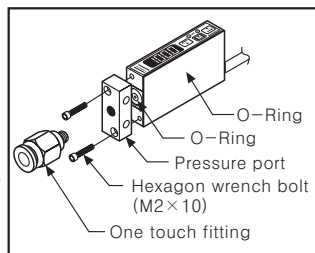

Caution

The tightening torque of one touch fitting and hexagon wrench should be Max. 10N · m and 2N · m. It may cause mechanical trouble.

Please don't use spanner to install as it may cause mechanical trouble.

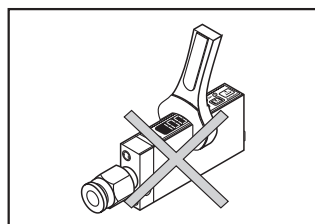
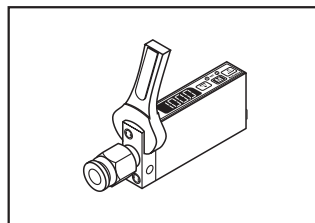

Accessory

PSA/PSB

- Pressure unit label

±100kPa	-101.3kPa	100kPa	1MPa
1.03kgf/cm ²	-1.03kgf/cm ²	1.03kgf/cm ²	10.3kgf/cm ²
14.50psi	-14.70psi	14.50psi	145.0psi
1.000bar	-1.013bar	1.000bar	10.000bar
150mmHg	-760mmHg	X10	X10
29.53mmHg	-29.53mmHg	X100	X100
102.0mmHg	-102.0mmHg	X1000	X1000

DISPLAY UNIT LABEL

PSA

- Port plug
- Bracket A
- Bracket B

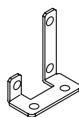
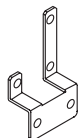

Proper usage

Caution

PSA, PSB Series is for detection of non corrosive gas. Do not use this product to detect corrosive gas or flammable gas etc.

- Please use this unit within range of specification, if applying pressure is larger than specification, it may not be working properly due to damage.
- After supplying power, it takes 3 sec. to work.
- When use switching regulator as power supply, power supply must be a good earth ground (F · G).

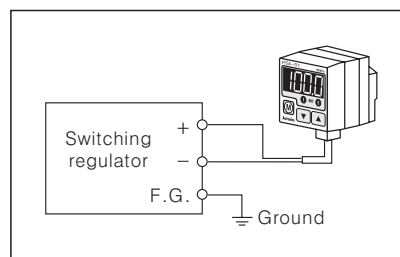

- It may cause malfunction by noise, if wire with power line or high voltage line.
- Do not insert any sharp or pointed object into pressure port.
It may cause mechanical trouble due to sensor damage.
- Do not use this unit for detecting flammable gas.
- Be sure that this unit avoids direct contact with water, oil, thinner etc.

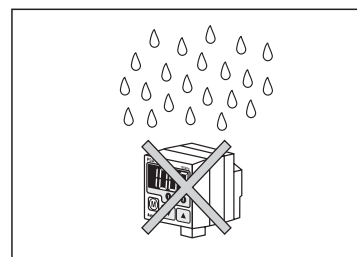

- Wiring must be done with power off.



www.wobit.com.pl

P.P.H. WOBit E.K.J. Ober s.c.
62-045 Pniewy, Dęborzyce 16
+48 61 22 27 422
wobit@wobit.com.pl