

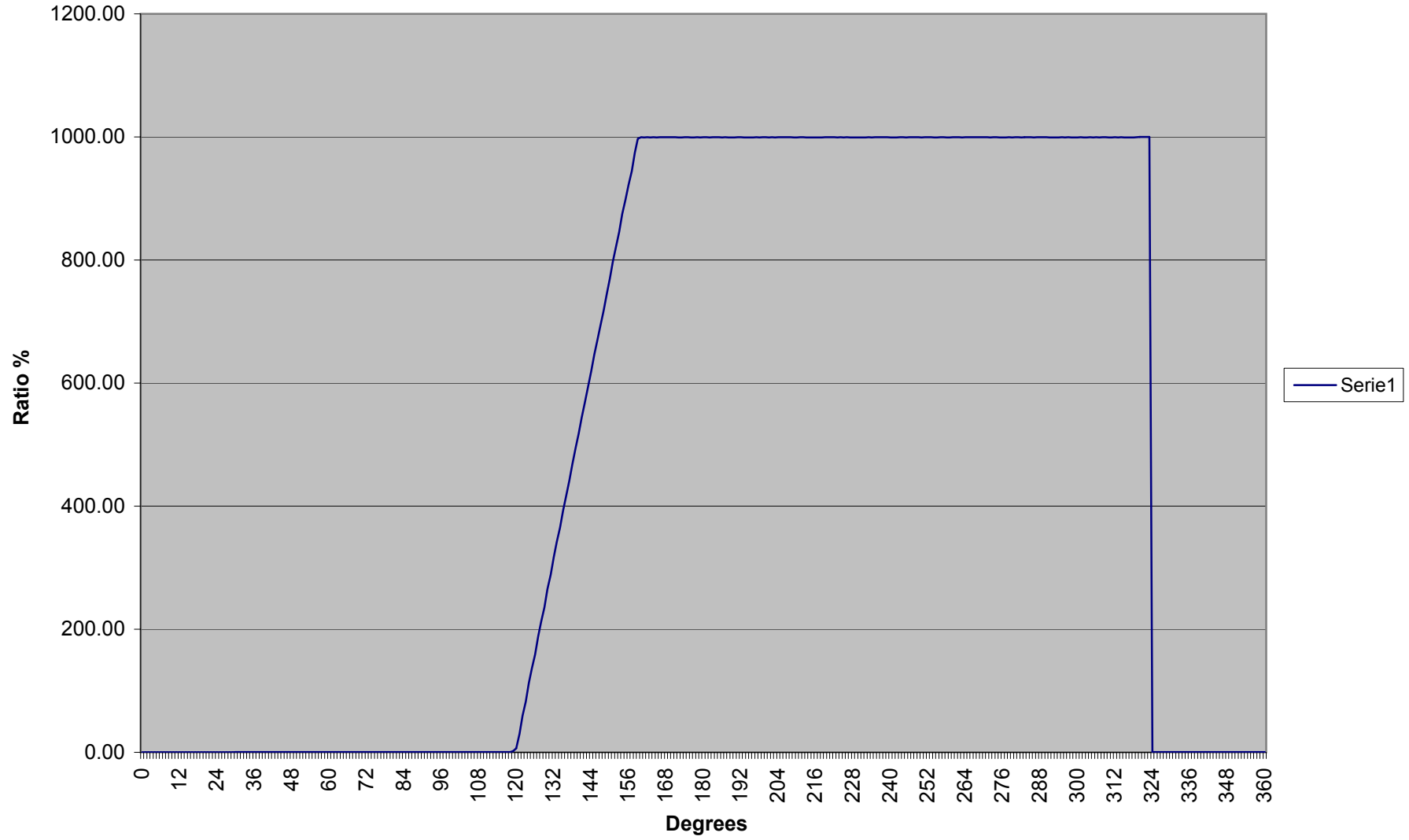

scp22e-40-30mm-1/4- 5k





scp22e-40-30mm-5k

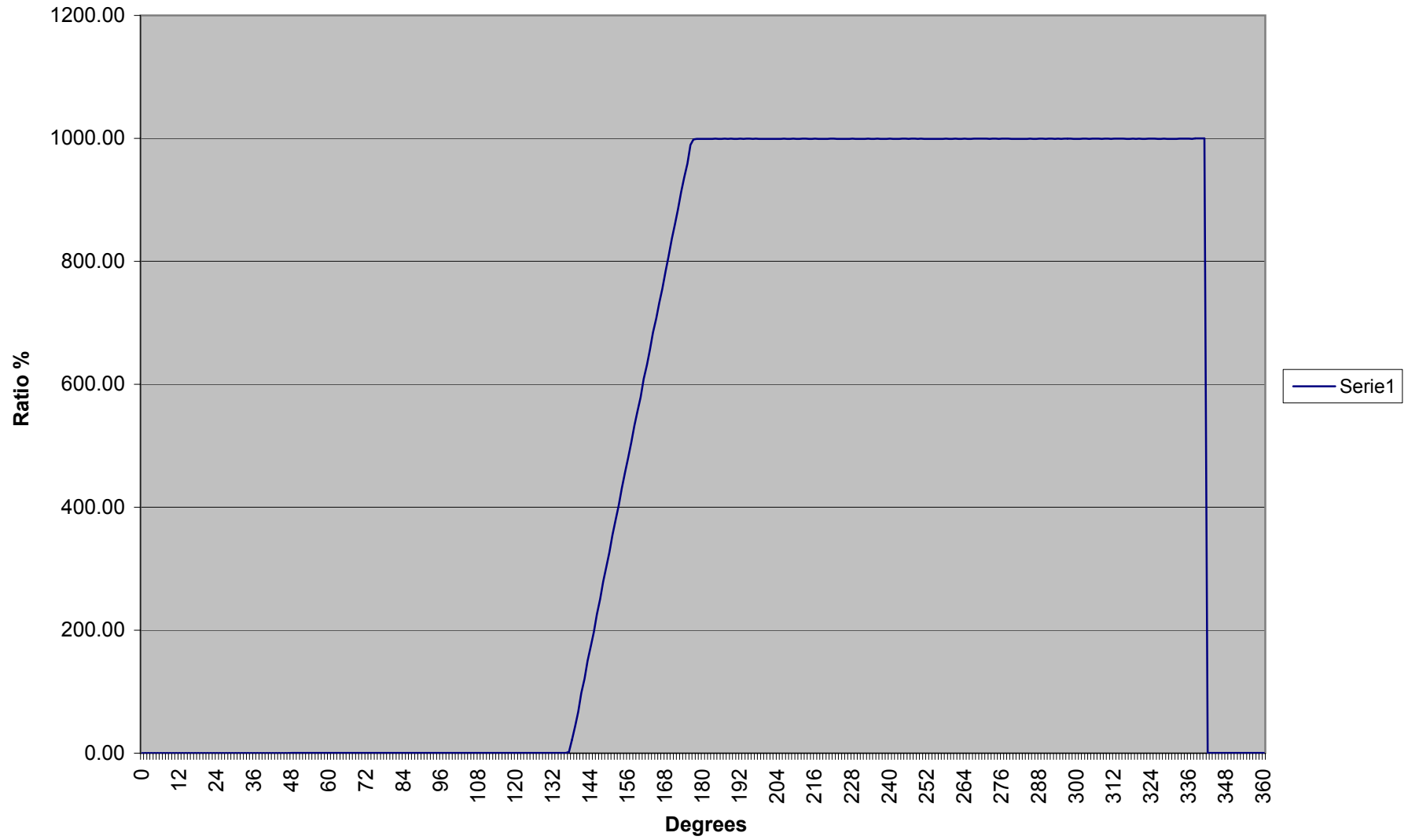



scp22e-40-5k

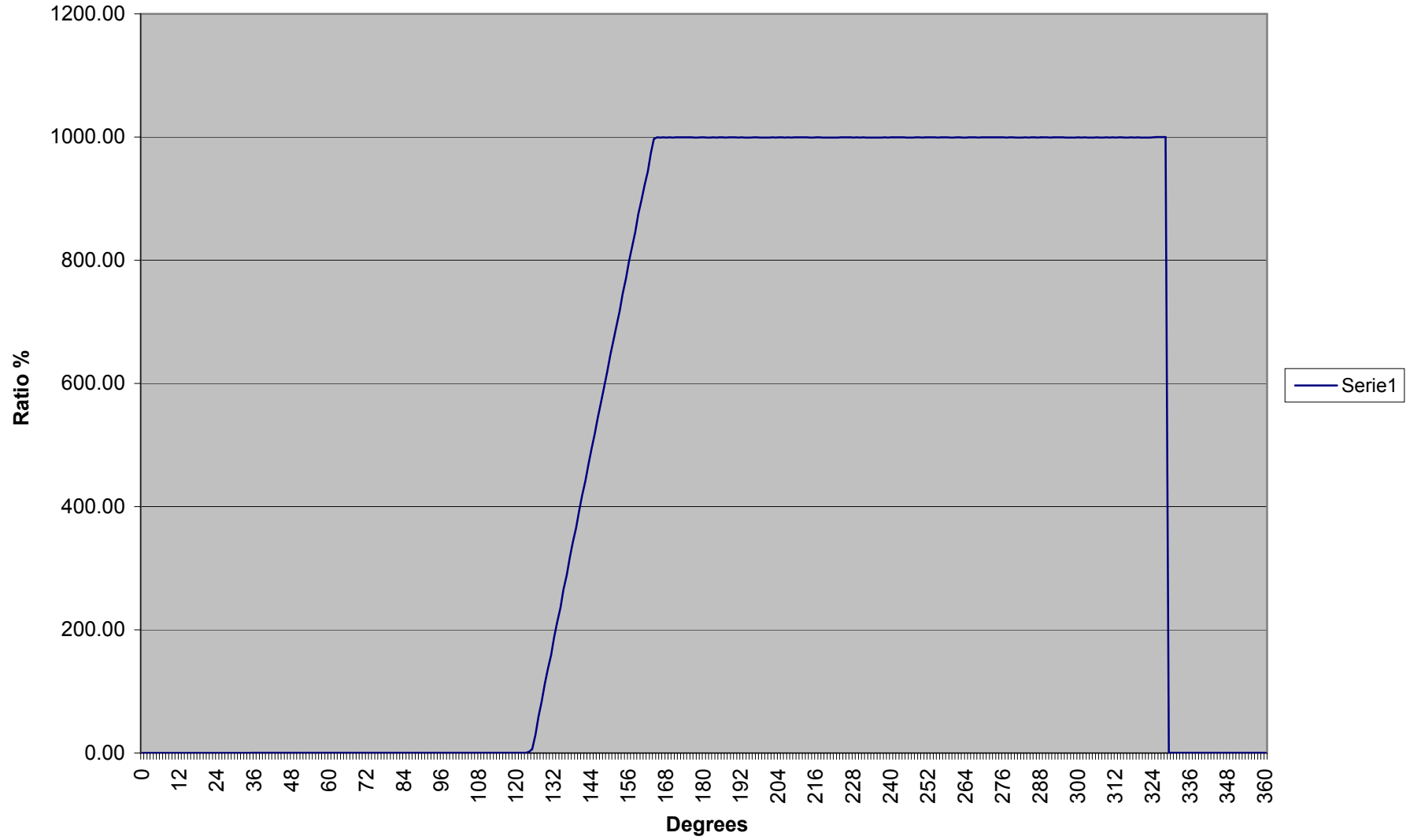



scp22e-40-2k

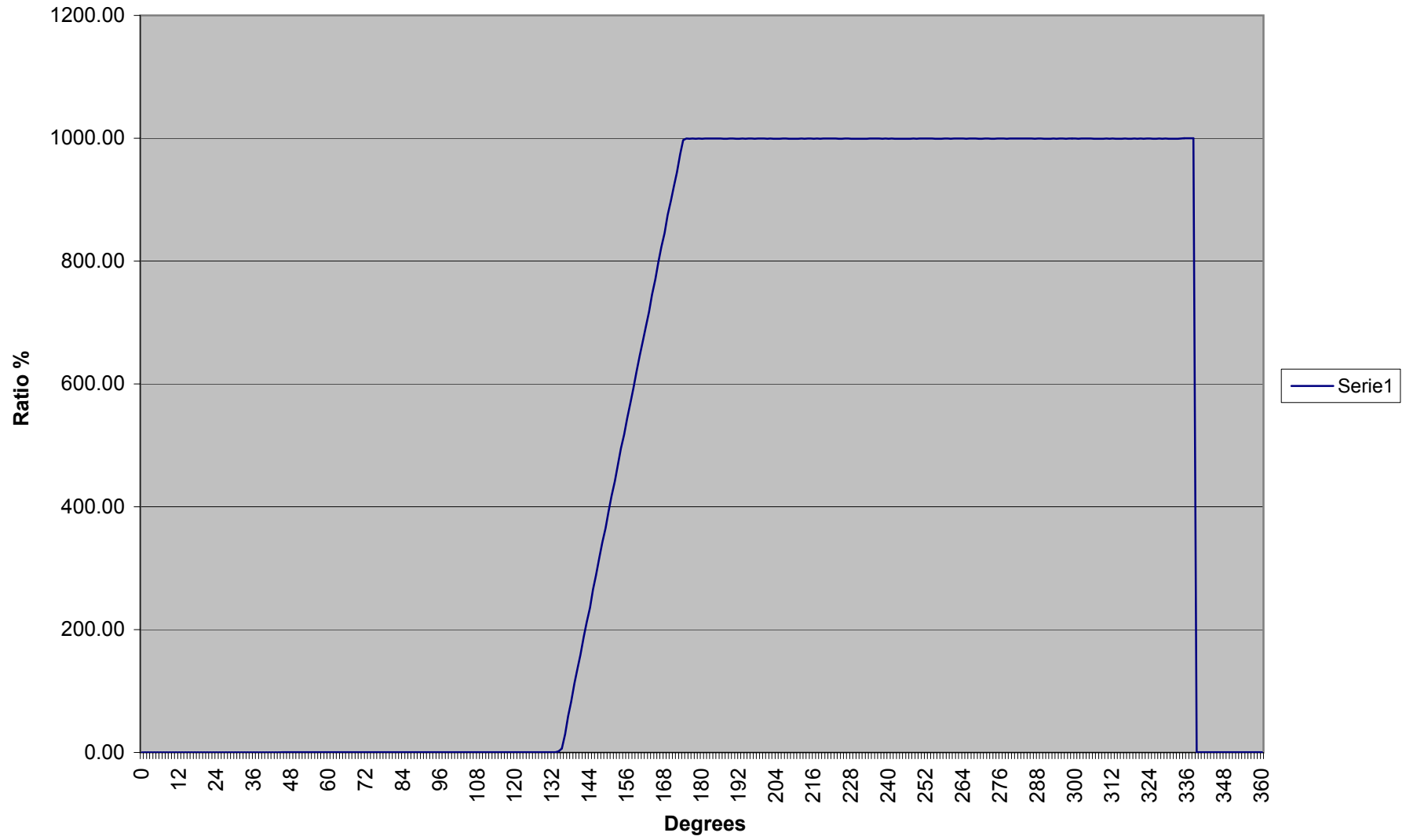



scp22e-40-1k

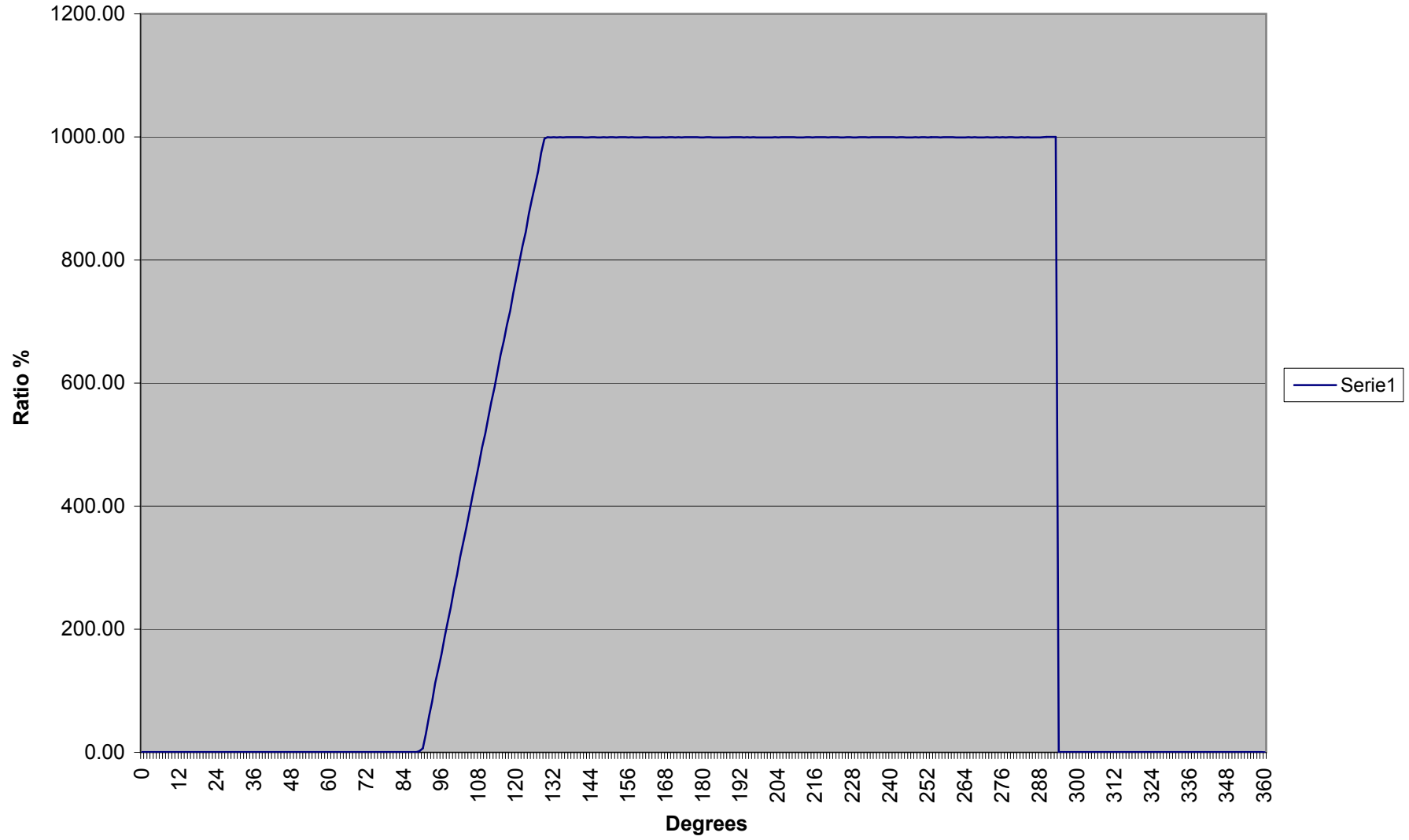

- Wirewound
- Bushingmount
- Low-cost Item
- RoHS Compliant

● Standard Dimensions



Model CP22E
(Plastic Housing)

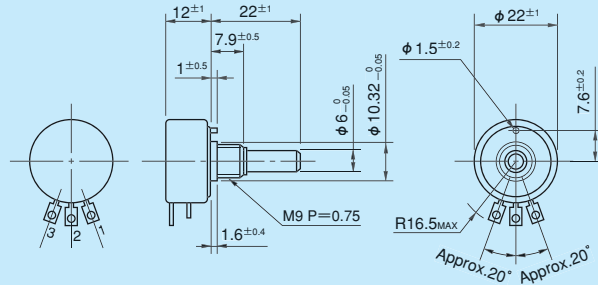

- Note: 1. 1 pc. each inner teeth washer and hex nut are attached.
2. Please process the mounting hole on the panel. The diameter should be $10.32\text{mm} + \frac{0.05}{0}$.

● General Specifications

Standard Resistance Range	50Ω to 10kΩ
Max. Practical Resistance Value	20kΩ
Total Resistance Tolerance	Standard Class ±3% (H) Precision Class ±1% (F)
Independent Linearity Tolerance	Standard Class ±0.5% Precision Class ±0.25% (±0.35% in case of within 1kΩ)
Power Rating	0.5W

Noise	Within 100Ω E.N.R.
Electrical Travel	355° ±5°
Mechanical Travel	360° (Endless)
Insulation Resistance	Over 1,000MΩ at 1,000V.D.C.
Dielectric Strength	1 minute at 1,000V.A.C.
Starting Torque	Within 5mN · m (50gf · cm)
Resistance Temperature Coefficient	±20p.p.m./°C
Mass	Approx. 20g

● Standard Resistance Values ■ No. of Wire Turns ■ Resistance Wire Used

Resist. Value (Ω)	50	100	200	500	1k	2k	5k	10k	※20k
No. of Wire Turns	300	370	470	450	570	740	1,000	1,270	1,670
Resist. Wire Used	Cu-Ni System			Ni-Cr System					

Note: Mark※ shows special high resistance value.

● Special Specifications Available

(In case of the potentiometer with special specifications, the general specifications and environmental specifications may change. Please consult us in advance.)

- Lower resistance values (10Ω, 20Ω)
- Extra tap (Available up to 1 tap)
- Shaft with front and rear extension (Rear shaft with 6mm dia. and 20mm length)
- Multi-ganged (Available up to 10 gangs)
- With stopper (Rotating angle is 320° and stopper strength is 0.6N · m [6kgf · cm])
- Special electrical travel
- Shaft dia. (φ 6.35mm) & bushing with inch dimension
- Special machining on the shaft

● Standard Dimensions

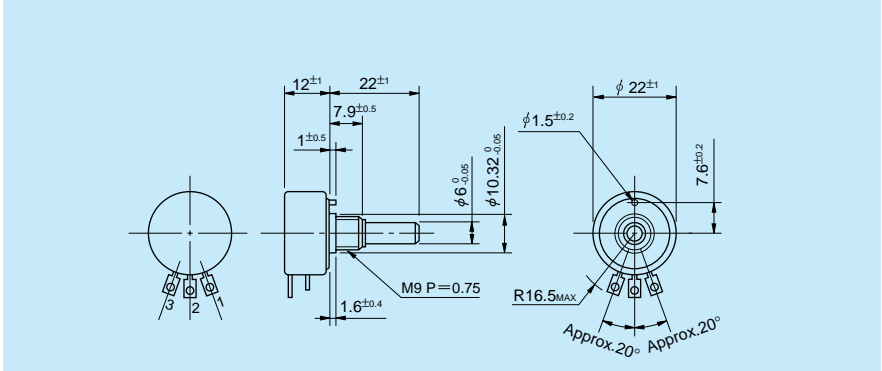
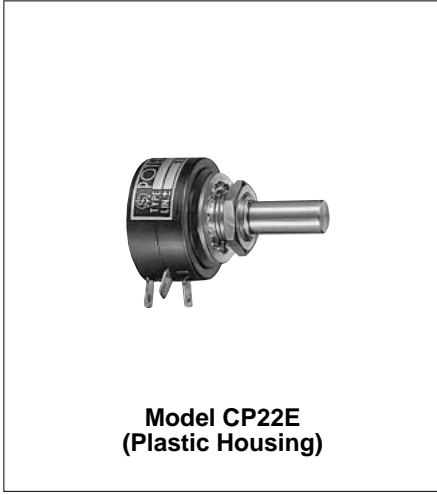

Note: 1. 1 pc. each inner teeth washer and hex nut are attached.
2. Please process the mounting hole on the panel to be mounted with this potentiometer by the diameter of 10.32mm^{+0.05}.

● General Specifications

Standard Resistance Range:	50Ω to 10kΩ	Noise:	Below 100Ω E.N.R.
Max. Practical Resistance Value:	20kΩ	Electrical Travel:	355° ±5°
Total Resistance Tolerance:	Standard Class ±3% (H) Precision Class ±1% (F)	Mechanical Travel:	360° (Endless)
Independent Linearity Tolerance:	Standard Class ±0.5% Precision Class ±0.25% (±0.35% in case of below 1kΩ)	Insulation Resistance:	Over 1,000MΩ at 1,000V.D.C.
Power Rating:	0.5W	Dielectric Strength:	1 minute at 1,000V.A.C.
		Starting Torque:	Below 5mN•m (50gf•cm)
		Max. Working Voltage:	250V
		Resist. Temperature Coefficient of Wire:	±20p.p.m./ °C
		Mass:	Approx. 20g

● Standard Resistance Values ■ No. of Wire Turns ■ Resistance Wire Used

Resist. Value (Ω)	50	100	200	500	1k	2k	5k	10k	* 20k
No. of Wire Turns	300	370	470	450	570	740	1,000	1,270	1,670
Resist. Wire Used	Cu-Ni System				Ni-Cr System				

Note: Mark * shows value at special higher practical resistance.

● **Special Specifications Available**

Lower resistance values (10Ω, 20Ω), Extra taps (Available up to 1 tap), Shaft with front and rear extension (Rear shaft with 6mm dia. and 20mm length), Multi-ganged (Available up to 10 gangs), With stopper (Rotating angle becomes 320° and stopper strength is 0.6N•m [6kgf•cm]), Special electrical travel, Shaft dia. (∅6.35mm)•bushing with inch dimensions, Special machining on the shaft.



1-TURN POTENTIOMETER

(Precision 1-turn, Wirewound & Conductive Plastic Element)

SAKAE 1-turn Potentiometers are fully continuous rotation potentiometers without stopper and are highly reliable in offering an excellent quality as well as a prolonged rotating life. There are 2 kinds of resistive element available in this series: Wirewound (**CP**) and Conductive Plastic (**FCP-A**) elements. You can easily make a best selection between these versions to your versatile application programs ranging from hand-operating use to servo applications.

CP or **FCP-A** is respectively contained in an aluminum housing case processed by electrolytic corrosion-proof plating in silver color (**CP**) and black color (**FCP-A**) with performances and dimensions according to U.S. MIL, and V.R.C.I. Standards. They are light in weight and small in size as well as of rigid construction. Selection of any desired item is possible among a variety of standard models, of which diameters are variable between 12mm and 50mm.

1-Turn ▶ Contact type

THE NOMENCLATURE OF SAKAE 1-TURN POT. SERIES

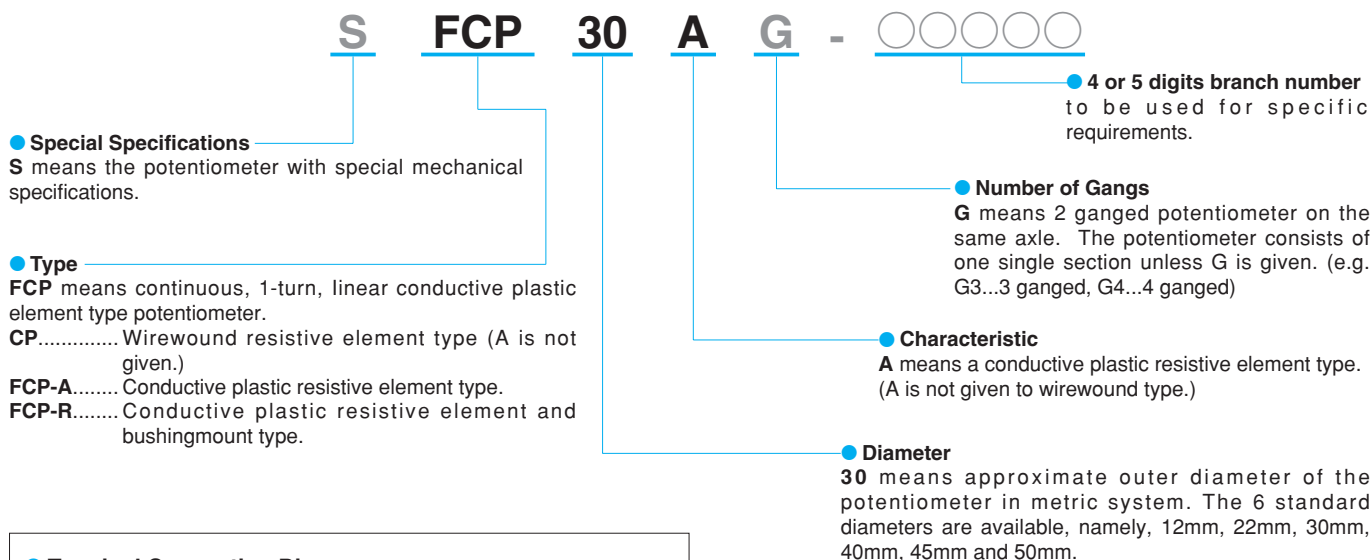

● Terminal Connection Diagram

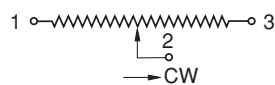

SELECTION GUIDE

Kind of Element	Diameter (mm)	Model No.	Features
Wirewound	φ 22	CP22C, CP22E	Bushingmount type low-cost pot. with outer diameter of 22mm.
	φ 22~ φ 50	CP22, CP30, CP45, CP50	Servomount type precision pots with outer diameter of 22mm to 50mm and excellent in temperature coefficient.
Conductive Plastic	φ 12, φ 22	FCP12AC, FCP22AC, FCP22E FCP22R	Bushingmount type low-cost pots with outer diameter of 12mm and 22mm.
		FCPS22AC	Servomount type low-cost pot. with outer diameter of 22mm.
	φ 12~ φ 50	FCP12A, FCP22A, FCP30A, FCP40A, FCP50A	Servomount type precision pots with outer diameter of 12mm to 50mm and with a patented multi-finger contact to make a good contact stability and excellent high speed tracking ability.

● General Performances

Kind of Element	Model No.	Standard Total Resistance Range (Ω)	Special Lower Resistance Values (Ω)	Special Higher Resistance Values (Ω)	Independent Linearity Tolerance (%)	Special Specifications					
						With Stopper	Front and Rear Shaft Extension	Extra Taps	Simple Sealing Type	With switch	Multi-ganged
Wirewound	CP22C	50~10k	10, 20	20k	±0.5~±0.25	○	○	○	○	—	—
	CP22E	50~10k	10, 20	20k	±0.5~±0.25	○	○	○	○	—	○
	CP22	50~10k	10, 20	20k	±0.5~±0.2	○	○	○	○	—	○
	CP30	50~20k	10, 20	50k	±0.5~±0.15	○	○	○	○	—	○
	CP45	50~20k	10, 20	50k	±0.5~±0.1	○	○	○	○	○	○
	CP50	50~20k	10, 20	50k	±0.5~±0.1	○	○	○	○	○	○
Conductive Plastic	FCP12AC	1k~10k	500	20k, 50k, 100k	±2.0~±1.0	○	○	○	○	—	—
	FCP12A	1k~10k	500	20k, 50k, 100k	±2.0~±1.0	○	○	○	○	—	—
	FCP22AC	1k~10k	500	20k, 50k, 100k	±1.5~±1.0	○	○	○	○	—	—
	FCP22E	1k~10k	500	20k, 50k, 100k	±1.5~±1.0	○	○	○	○	—	○
	FCP22R	1k~10k	500	20k, 50k, 100k	±1.5~±1.0	—	—	○	—	—	—
	FCPS22AC	1k~10k	500	20k, 50k, 100k	±1.0~±0.5	○	○	○	○	—	—
	FCP22A	1k~10k	500	20k, 50k, 100k	±1.0~±0.3	○	○	○	○	—	○
	FCP30A	1k~10k	500	20k, 50k, 100k	±1.0~±0.2	○	○	○	○	—	○
	FCP40A	1k~10k	500	20k,50k,100k,200k	±0.5~±0.1	○	○	○	○	○	○
FCP50A	1k~10k	500	20k, 50k, 100k, 200k, 500k	±0.5~±0.05	○	○	○	○	○	○	

Note: 1. For detailed performances, please refer to specifications of each model in this catalog.

● Environmental Performances

Model Nos.	CP22C, CP22E, CP22, CP30, CP45, CP50 (LNB22)	FCP12AC, FCP12A, FCP22E, FCP22R, FCP22AC, FCPS22AC	FCP22A, FCP30A, FCP40A, FCP50A
Operating Temperature Range	-55°C ~ +105°C	-55°C ~ +105°C	-55°C ~ +125°C
Temperature Cycle	5 cycles under -55°C ~ +105°C Total resistance value variation: within ± 5% No mechanical damage	5 cycles under -55°C ~ +105°C Total resistance value variation: within ± 10% No mechanical damage	5 cycles under -55°C ~ +125°C Total resistance value variation: within ± 10% No mechanical damage
Exposure at Low Temperature	24 hours at -55°C Total resistance value variation: within ± 5% No mechanical damage	24 hours at -55°C Total resistance value variation: within ± 5% No mechanical damage	24 hours at -55°C Total resistance value variation: within ± 5% Output voltage variation: within 0.5% No mechanical damage
Exposure at High Temperature	1,000 hours at 105°C Total resistance value variation: within ± 5% No mechanical damage	1,000 hours at 105°C Total resistance value variation: within ± 10% No mechanical damage	1,000 hours at 125°C Total resistance value variation: within ± 10% Output voltage variation: within 0.5% No mechanical damage
Vibration	10Hz to 2,000Hz 147m/s ² 12 hours Total resistance value variation: within ± 5% No mechanical and electrical damage	10Hz to 2,000Hz 147m/s ² 12 hours Total resistance value variation: within ± 2% No mechanical and electrical damage	10Hz to 2,000Hz 147m/s ² 12hours Total resistance value variation: within ± 2% No mechanical and electrical damage
Shock	490m/s ² 11ms 18 times Total resistance value variation: within ± 1% No mechanical and electrical damage	490m/s ² 11ms 18 times Total resistance value variation: within ± 1% No mechanical and electrical damage	490m/s ² 11ms 18 times Total resistance value variation: within ± 1% No mechanical and electrical damage
Moisture Resistance	40°C 95% RH 240 hours Total resistance value variation: within ± 10% Insulation resistance: over 10MΩ	40°C 95% RH 120 hours Total resistance value variation: within ± 10% Insulation resistance: over 10MΩ	40°C 95% RH 120 hours Total resistance value variation: within ± 10% Insulation resistance: over 10MΩ
Rotational Life Expectancy (at 25°C)	No load at 40 r.p.m. 1,000,000 shaft revolutions 500,000 shaft revolutions for CP22C & CP22E Total resistance value variation: within ± 5% against initial value Independent linearity tolerance: within 150% of specified value Noise: within 500 Ω E.N.R.	No load at 400 r.p.m., inverting every 15 minutes FCP12AC...5,000,000 shaft revolutions FCP12A } FCP22E } 10,000,000 shaft revolutions FCP22R } FCP22AC } FCPS22AC...20,000,000 shaft revolutions Total resistance value variation: within ± 10% against initial value Independent linearity tolerance: within 150% of specified value Output smoothness: within 150% of specified value	No load at 400 r.p.m., inverting every 15 minutes FCP22A...50,000,000 shaft revolutions Total resistance value variation: within ± 10% against initial value Independent linearity tolerance: within 150% of specified value Output smoothness: within 150% of specified value

Note: 2. In case of the potentiometer with special resistance values and special specifications, the above performances may vary and therefore, please consult us in advance, separately.
 3. As for operating temperature range, we can't always guarantee exactly the same performances and values in actual industrial applications even if the temperature out there is within standard range. (Please see page 23 in this catalog for further details.)
 4. All values of each parameter were measured under standard temperature and standard testing conditions. For the values during the tests and other characteristics, please ask us separately.
 5. In case of model LNB22, all values mentioned in the above table are reference only.