



Representative photograph, actual product appearance may vary.

Due to regional agency approval requirements, some products may not be available in your area. Please contact your regional Honeywell office regarding your product of choice.

RV6NAYSD103A

RV6 Series Industrial Potentiometer, Conductive Plastic Element, Solder hook Terminals, 0.5 W Power Rating, 10 kOhm Resistance Value

Features

- Compact - 12,7 mm [0.5 in] diameter
- Conductive plastic element
- Linear taper
- Robust nickel-plated brass shaft and bushings
- Meets MIL-PRF-94 standards
- Solder hook terminals

Typical Applications

- Manual controls
- Medical equipment
- Telecommunications

Description

The RV6 Series is a military qualified potentiometer made in accordance to MIL-PRF-94 specifications. It offers a 1/2 watt power rating and a conductive plastic element.

Product Specifications	
Potentiometer Type	Industrial
Element Type	Conductive Plastic
Terminal Type	Solder Hook
Power Rating	0.5 W
Resistance Value	10 kOhm
Resistance Tolerance	± 10 %
Linearity	± 5 %
Bushing Thread	6,35 mm [0.25 in] x 32 NEF-2A
Bushing length	6,35 mm [0.25 in]
Bushing Type	Standard
Shaft Diameter	3,18 mm [0.125 in]
Shaft length	22,22 mm [0.875 in]
Shaft Ending	Slotted
Body	12.7 mm [0.5 in] diameter, ± 0.79 mm [0.031 in]
Electrical Taper	Linear
Operating Temperature	-40 °C to 120 °C [-40 °F to 248 °F]
Working Voltage (Max.)	350 V
Rotational Life	50000 cycles
Mechanical Rotation	295°
Availability	Global
Series Name	RV6 Series
UNSPSC Code	4111363300
UNSPSC Commodity	4111363300 Potentiometers

Honeywell

RV6NAYSD103A

RV6 Series Industrial Potentiometer, Conductive Plastic Element, Solder hook Terminals, 0.5 W Power Rating, 10 kOhm Resistance Value

For Reference Only in/mm

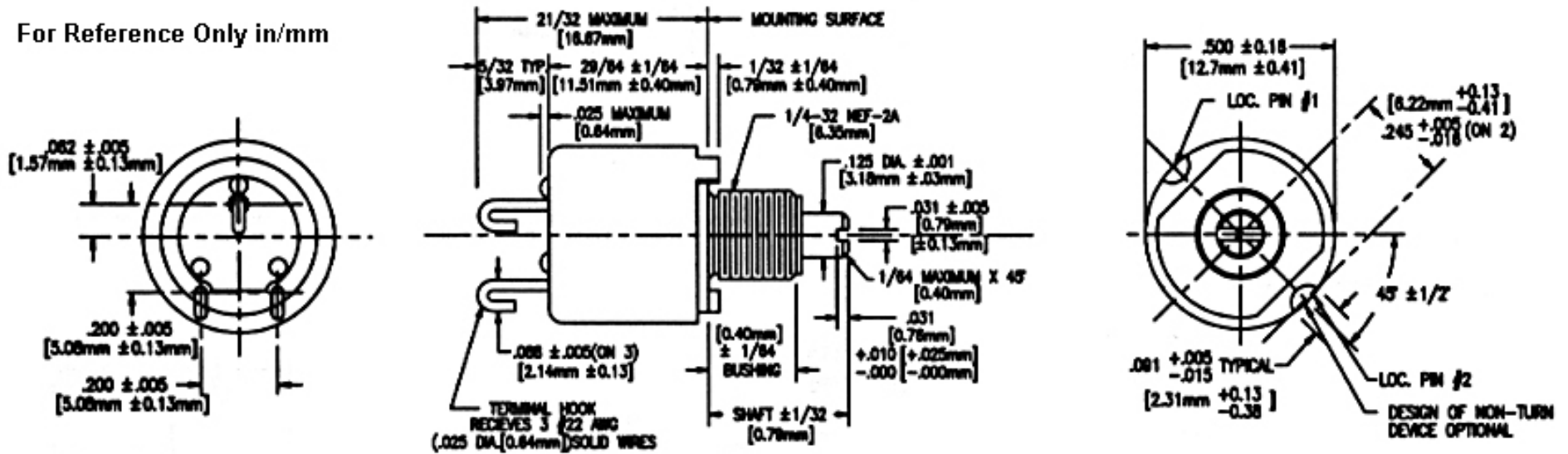

SPLIT LOCKING BUSHING

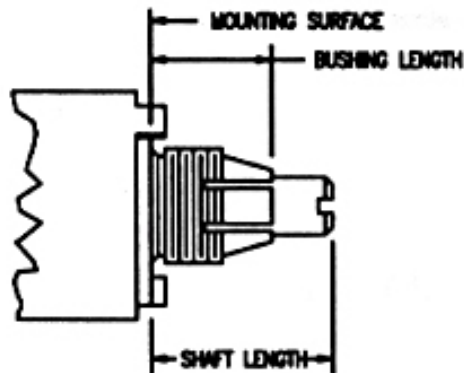

Honeywell

RV6NAYSD103A

RV6 Series Industrial Potentiometer, Conductive Plastic Element, Solder hook Terminals, 0.5 W Power Rating, 10 kOhm Resistance Value

 WARNING

PERSONAL INJURY

DO NOT USE these products as safety or emergency stop devices, or in any other application where failure of the product could result in personal injury.

Failure to comply with these instructions could result in death or serious injury.

 WARNING

MISUSE OF DOCUMENTATION

- The information presented in this product sheet (or catalog) is for reference only. DO NOT USE this document as product installation information.
- Complete installation, operation and maintenance information is provided in the instructions supplied with each product.

Failure to comply with these instructions could result in death or serious injury.