

# MODEL 89

## 3/4" Rectangular

## Multiturn

## Cermet Trimming

## Potentiometer



1

### ELECTRICAL

Standard Resistance Range, Ohms	10 to 2Meg
Standard Resistance Tolerance	±10% (<100 Ohms = ±20%)
Input Voltage, Maximum	200 Vdc or rms not to exceed power rating
Slider Current, Maximum	100mA or within rated power, whichever is less
Power Rating, Watts	0.75 at 85°C derating to 0 at 125°C
End Resistance, Maximum	2 Ohms
Actual Electrical Travel, Turns, Nominal	20
Dielectric Strength	1,000 Vrms
Insulation Resistance, Minimum	1,000 Megohms
Resolution	Essentially infinite
Contact Resistance Variation, Maximum	1% or 1 Ohm, whichever is greater

### ENVIRONMENTAL

Seal	85°C Fluorinert® (No Leaks)
Temperature Coefficient, Maximum	±100ppm/°C
Operating Temperature Range	-55°C to +125°C
Thermal Shock	5 cycles, -55°C to +125°C (1% ΔRT, 1% ΔVR)
Moisture Resistance	Ten 24 hour cycles (1% ΔRT, IR 100 Megohms Min.)
Shock, 6ms Sawtooth	100G's (1% ΔRT, 1% ΔVR)
Vibration	20G's, 10 to 2,000 Hz (1% ΔRT, 1% ΔVR)
High Temperature Exposure	250 hours at 125°C (2% ΔRT, 2% ΔVR)
Rotational Life	200 cycles (3% ΔRT)
Load Life at 0.5 Watts	1,000 hours at 70°C (2% ΔRT)
Resistance to Solder Heat	260°C for 10 sec. (1% ΔRT)

### MECHANICAL

Mechanical Stops	Clutch Action, both ends
Torque, Starting Maximum	5 oz.-in. (0.035 N-m)
Weight, Nominal	.05 oz. (1.4 grams)

Fluorinert® is a registered trademark of 3M Company.  
Specifications subject to change without notice.

**LOW PROFILE (Inch/mm)**

**Model 89P and 90P**

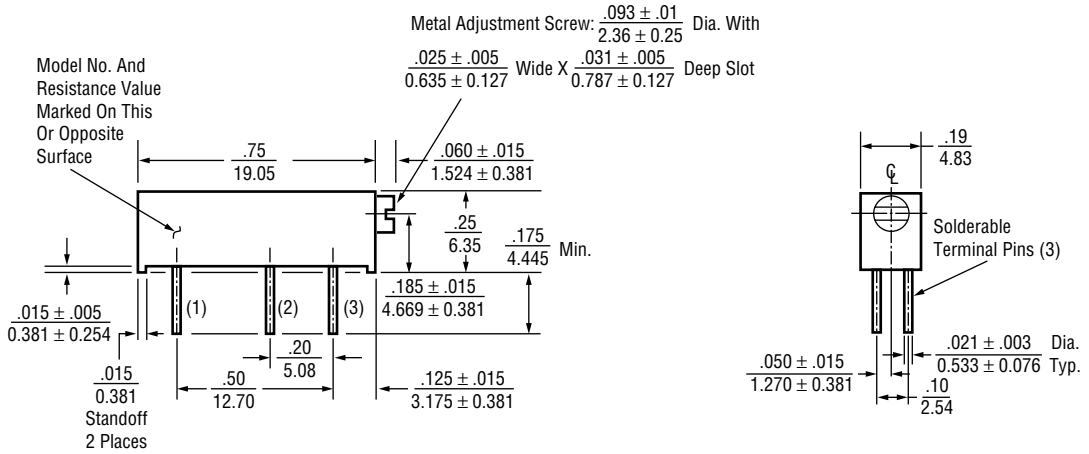

Note: Model 89P dimensions applicable to all other models except as noted

**Model 89W**

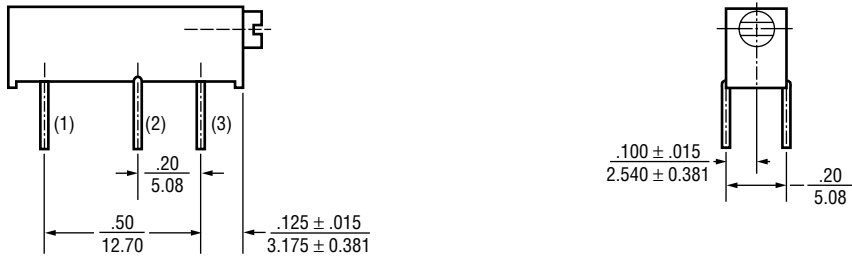

**Model 89X**



**Model 89PH**

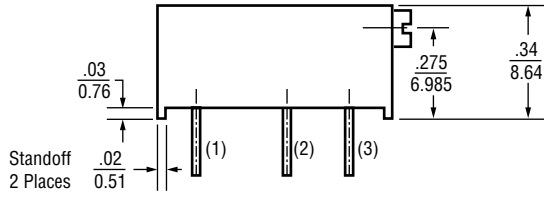

Circuit Diagram Marked  
On This Surface

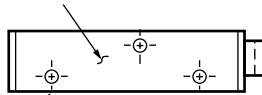

Housing:  
Molded Plastic  
(All Models)

Pin Dimensions Same For 89P And 89PH

**Model 89WH**

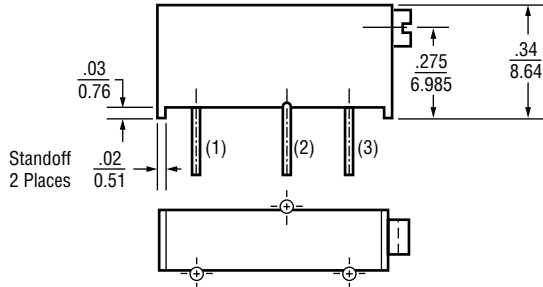

Pin Dimensions Same For 89W And 89WH

**Model 89XH**

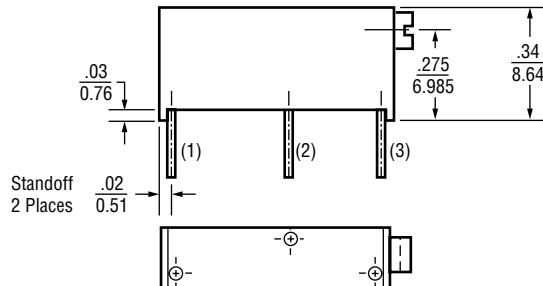

Pin Dimensions Same For 89X And 89XH

## PANEL MOUNT ADAPTER (Inch/mm)

### Model 89B

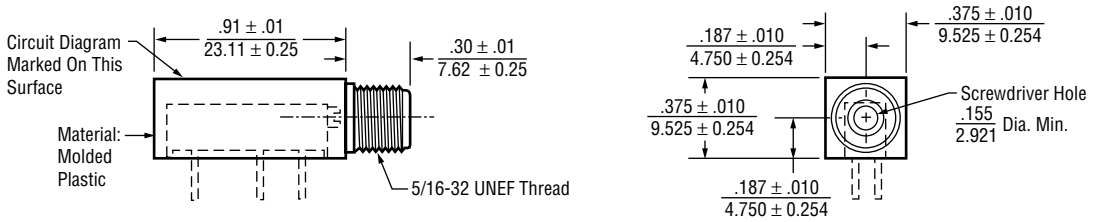

## STANDARD RESISTANCE VALUES, OHMS

10	200	5K	50K	500K
20	500	10K	100K	1Meg
50	1K	20K	200K	2Meg
100	2K	25K	250K	

## PACKAGING

### Standard: Boxes

Capacity = 100 Units (89P)  
50 Units (All other styles)

### Option: Tubes

All units oriented with #1 pin to same side.

Magazine	Width	=	0.28"
	Height	=	0.65"
	Length	=	21.5"
	Capacity	=	25 Units

**ORDERING INFORMATION**

**Standard:**

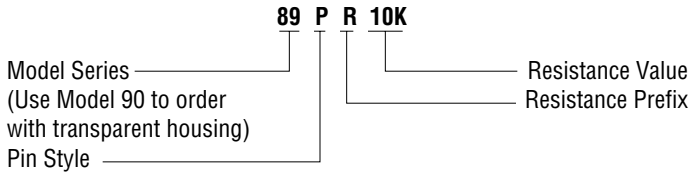

**Option:**

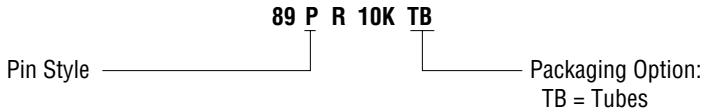

**Option:**

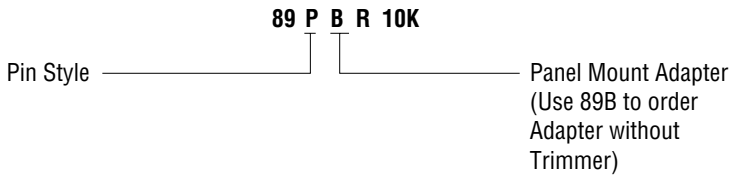

**CIRCUIT DIAGRAM**

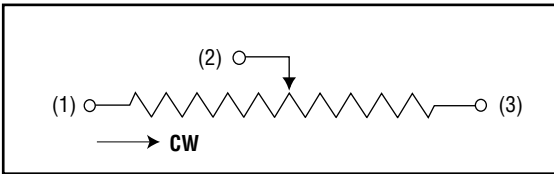

**NOTES**

Metric equivalents, based on 1 inch = 25.4mm are rounded to the same number of significant figures as in the original English units and are provided for general information only.

Tolerances unless otherwise specified:  
 Linear = ± .01 inches (.25mm)  
 Angular = ± 2 degrees

