

Features

- Single-Turn / Cermet / Industrial / Sealed
- Miniature package
- Rotor designed for automatic machine adjust interface
- Withstands harsh environments and immersion cleaning processes

■ Available on tape and reel packaging (see page 71)

3362 - 1/4" Square Trimming Potentiometer

Electrical Characteristics

Standard Resistance Range 10 to 2 megohms
 (see standard resistance table)
 Resistance Tolerance ±10% std.
 (tighter tolerance available)
 Absolute Minimum Resistance 1% or 2 ohms
 (whichever is greater)
 Contact Resistance Variation 1% or 3 ohms max.
 (whichever is greater)
 Adjustability
 Voltage ±0.05%
 Resistance ±0.15%
 Resolution Infinite
 Insulation Resistance 500 vdc.
 1,000 megohms min.

Dielectric Strength
 Sea Level 900 vac
 80,000 Feet 350 vac
 Adjustment Angle 240° nom.

Environmental Characteristics

Power Rating (300 volts max.)
 70°C 0.50 watt
 125°C 0 watt
Temperature Range
 -55°C to +125°C
Temperature Coefficient
 ±100ppm/°C
Seal Test 85°C Fluorinert*
Humidity MIL-STD-202 Method 103
 96 hours
 (2% ΔTR; 10 Megohms IR)
Vibration 30G (1% ΔTR; 1% ΔVR)
Shock 100G (1% ΔTR; 1% ΔVR)
Load Life
 1,000 hours 0.5 watt @ 70°C
 (3% ΔTR; 3% or 3 ohms, whichever is greater, CRV)
Rotational Life 200 cycles
 (4% ΔTR; 3% or 3 ohms, whichever is greater, CRV)

Physical Characteristics

Mechanical Angle 270° nom.
Torque 3.0 oz-in. max.
Stop Strength 7.0 oz-in. min.
Terminals Solderable pins
Weight 0.02 oz.
Marking Resistance code, terminal numbers, manufacturer's model number, style and date code
Wiper Positioned at 50% nominal
Flammability U.L. 94V-0
Standard Packaging 50 pcs. per tube
Adjustment Tool H-90

FLUORINERT IS A REGISTERED TRADEMARK OF 3M CO.

Common Dimensions Top Adjust

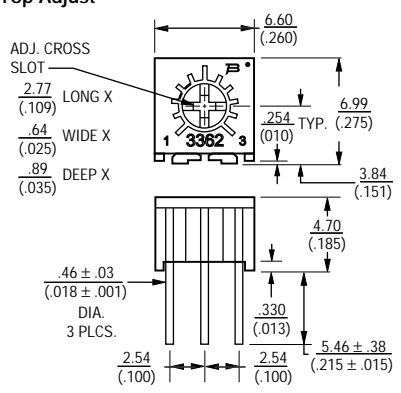

3362H

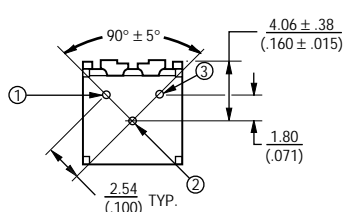

3362P

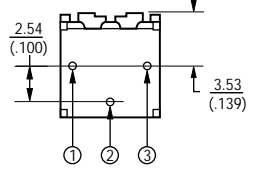

3362R

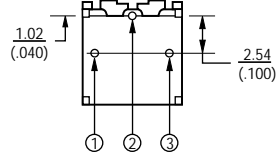

3362U

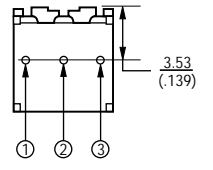

Common Dimensions Side Adjust

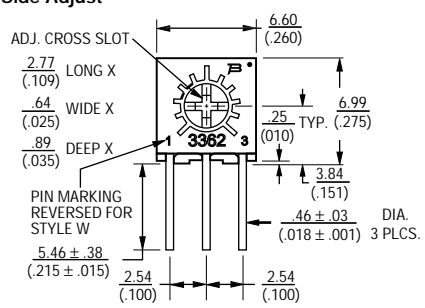

3362M

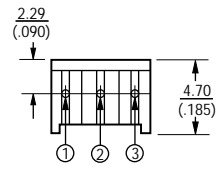

3362S

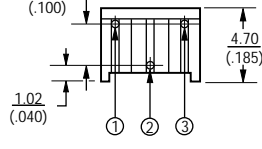

3362W

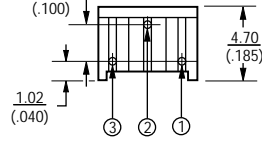

3362X

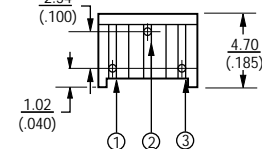

TOLERANCES: ± 0.25 (.010) EXCEPT WHERE NOTED

DIMENSIONS ARE: METRIC (INCHES)

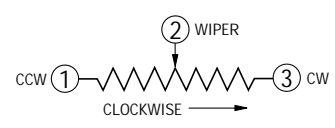

3362 - 1/4" Square Trimming Potentiometer



How to Order

3362 P - 1 - 502

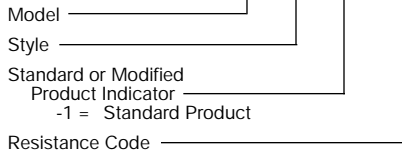

Consult factory for other available options.

Standard Resistance Table

Resistance (Ohms)	Resistance Code
10	100
20	200
50	500
100	101
200	201
500	501
1,000	102
2,000	202
5,000	502
10,000	103
20,000	203
25,000	253
50,000	503
100,000	104
200,000	204
250,000	254
500,000	504
1,000,000	105
2,000,000	205

Popular values listed in boldface. Special resistances available.

SHADED AREAS TYPICALLY NOT STOCKED BY DISTRIBUTORS AND NOT RECOMMENDED FOR NEW DESIGNS.