

## STEPPER MOTOR CONTROLLERS

- NORMAL/WAVE DRIVE
- HALF/FULL STEP MODES
- CLOCKWISE/ANTICLOCKWISE DIRECTION
- SWITCHMODE LOAD CURRENT REGULATION
- PROGRAMMABLE LOAD CURRENT
- FEW EXTERNAL COMPONENTS
- RESET INPUT & HOME OUTPUT
- ENABLE INPUT

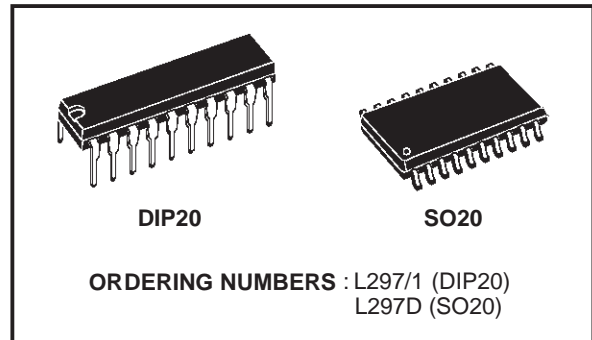

### DESCRIPTION

The L297 Stepper Motor Controller IC generates four phase drive signals for two phase bipolar and four phase unipolar step motors in microcomputer-controlled applications. The motor can be driven in half step, normal and wave drive modes and on-chip PWM chopper circuits permit switch-mode control of the current in the windings. A feature of

this device is that it requires only clock, direction and mode input signals. Since the phase are generated internally the burden on the microprocessor, and the programmer, is greatly reduced. Mounted in DIP20 and SO20 packages, the L297 can be used with monolithic bridge drives such as the L298N or L293E, or with discrete transistors and darlingtonts.

### ABSOLUTE MAXIMUM RATINGS

Symbol	Parameter	Value	Unit
$V_s$	Supply voltage	10	V
$V_i$	Input signals	7	V
$P_{tot}$	Total power dissipation ( $T_{amb} = 70^\circ\text{C}$ )	1	W
$T_{stg}, T_j$	Storage and junction temperature	-40 to + 150	$^\circ\text{C}$

### TWO PHASE BIPOLAR STEPPER MOTOR CONTROL CIRCUIT

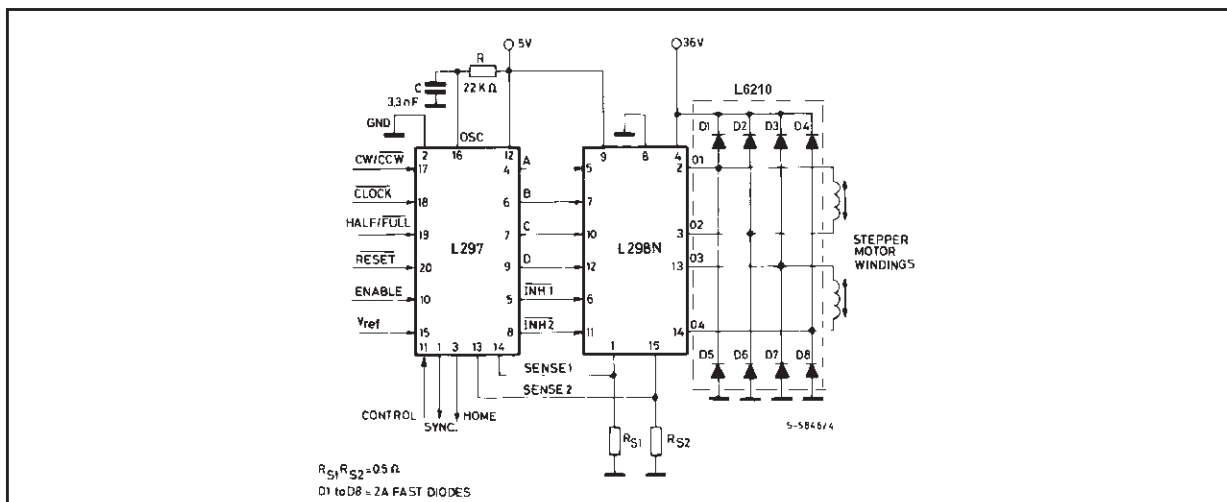

PIN CONNECTION (Top view)

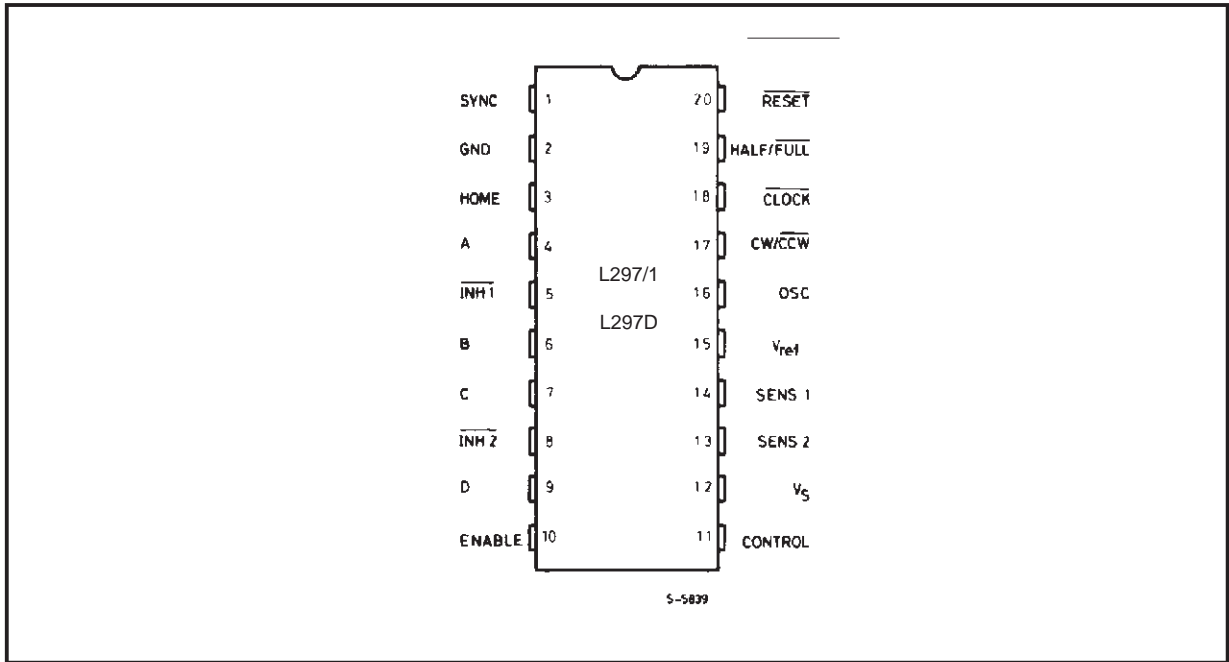

BLOCK DIAGRAM (L297/1 - L297D)

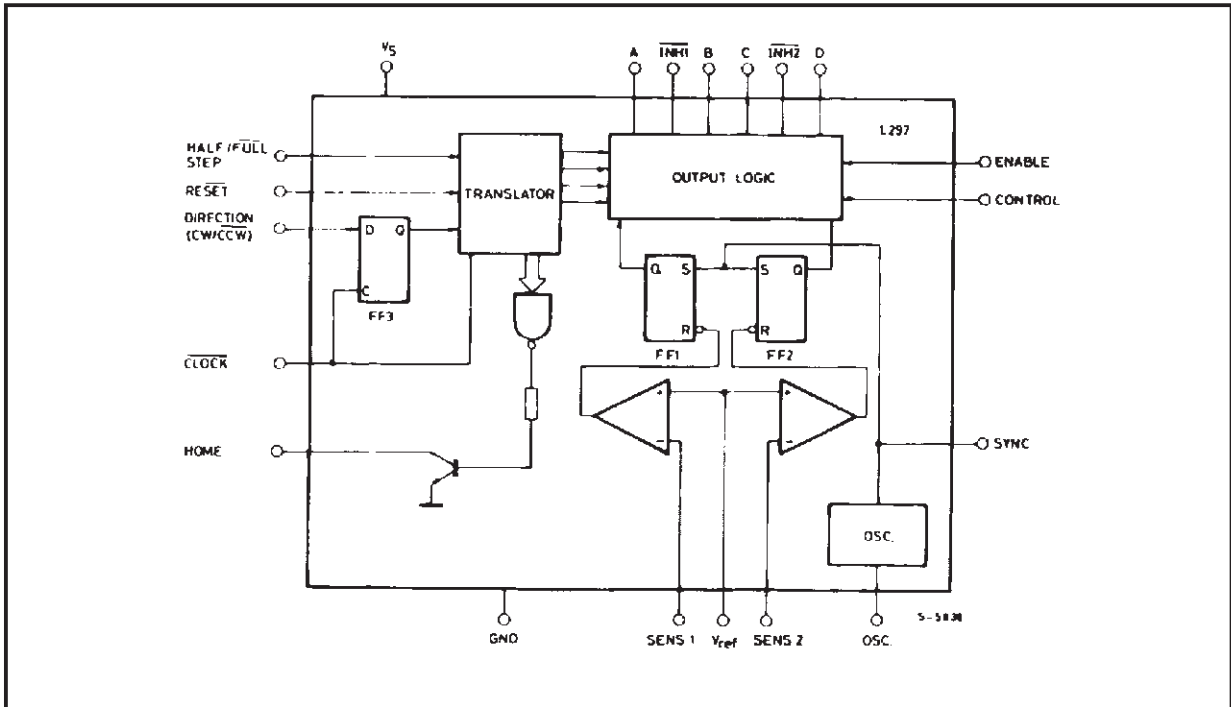

## PIN FUNCTIONS - L297/1 - L297D

N°	NAME	FUNCTION
1	SYNC	Output of the on-chip chopper oscillator. The SYNC connections of all L297s to be synchronized are connected together and the oscillator components are omitted on all but one. If an external clock source is used it is injected at this terminal.
2	GND	Ground connection.
3	HOME	Open collector output that indicates when the L297 is in its initial state (ABCD = 0101). The transistor is open when this signal is active.
4	A	Motor phase A drive signal for power stage.
5	$\overline{\text{INH1}}$	Active low inhibit control for driver stage of A and B phases. When a bipolar bridge is used this signal can be used to ensure fast decay of load current when a winding is de-energized. Also used by chopper to regulate load current if CONTROL input is low.
6	B	Motor phase B drive signal for power stage.
7	C	Motor phase C drive signal for power stage.
8	$\overline{\text{INH2}}$	Active low inhibit control for drive stages of C and D phases. Same functions as INH1.
9	D	Motor phase D drive signal for power stage.
10	ENABLE	Chip enable input. When low (inactive) INH1, INH2, A, B, C and D are brought low.
11	CONTROL	Control input that defines action of chopper. When low chopper acts on INH1 and INH2; when high chopper acts on phase lines ABCD.
12	$V_s$	5V supply input.
13	SENS <sub>2</sub>	Input for load current sense voltage from power stages of phases C and D.
14	SENS <sub>1</sub>	Input for load current sense voltage from power stages of phases A and B.
15	$V_{ref}$	Reference voltage for chopper circuit. A voltage applied to this pin determines the peak load current.
16	OSC	An RC network (R to $V_{CC}$ , C to ground) connected to this terminal determines the chopper rate. This terminal is connected to ground on all but one device in synchronized multi -L297 configurations. $f \cong 1/0.69 RC$
17	CW/ $\overline{\text{CCW}}$	Clockwise/counterclockwise direction control input. Physical direction of motor rotation also depends on connection of windings. Synchronized internally therefore direction can be changed at any time.
18	$\overline{\text{CLOCK}}$	Step clock. An active low pulse on this input advances the motor one increment. The step occurs on the rising edge of this signal.

## PIN FUNCTIONS - L297/1 - L297D (continued)

N°	NAME	FUNCTION
19	HALF/FULL	Half/full step select input. When high selects half step operation, when low selects full step operation. One-phase-on full step mode is obtained by selecting FULL when the L297's translator is at an even-numbered state. Two-phase-on full step mode is set by selecting FULL when the translator is at an odd numbered position. (The home position is designate state 1).
20	RESET	Reset input. An active low pulse on this input restores the translator to the home position (state 1, ABCD = 0101).

## THERMAL DATA

Symbol	Parameter	DIP20	SO20	Unit
$R_{th-j-amb}$	Thermal resistance junction-ambient	max 80	100	°C/W

## CIRCUIT OPERATION

The L297 is intended for use with a dual bridge driver, quad darlington array or discrete power devices in step motor driving applications. It receives step clock, direction and mode signals from the systems controller (usually a microcomputer chip) and generates control signals for the power stage.

The principal functions are a translator, which generates the motor phase sequences, and a dual PWM chopper circuit which regulates the current in the motor windings. The translator generates three different sequences, selected by the HALF/FULL input. These are normal (two phases energised), wave drive (one phase energised) and half-step (alternately one phase energised/two phases energised). Two inhibit signals are also generated by the L297 in half step and wave drive modes. These signals, which connect directly to the L298's enable inputs, are intended to speed current decay when a winding is de-energised. When the L297 is used to drive a unipolar motor the chopper acts on these lines.

An input called CONTROL determines whether the chopper will act on the phase lines ABCD or the inhibit lines INH1 and INH2. When the phase lines

are chopped the non-active phase line of each pair (AB or CD) is activated (rather than interrupting the line then active). In L297 + L298 configurations this technique reduces dissipation in the load current sense resistors.

A common on-chip oscillator drives the dual chopper. It supplies pulses at the chopper rate which set the two flip-flops FF1 and FF2. When the current in a winding reaches the programmed peak value the voltage across the sense resistor (connected to one of the sense inputs SENS<sub>1</sub> or SENS<sub>2</sub>) equals  $V_{ref}$  and the corresponding comparator resets its flip flop, interrupting the drive current until the next oscillator pulse arrives. The peak current for both windings is programmed by a voltage divider on the  $V_{ref}$  input.

Ground noise problems in multiple configurations can be avoided by synchronising the chopper oscillators. This is done by connecting all the SYNC pins together, mounting the oscillator RC network on one device only and grounding the OSC pin on all other devices.

**MOTOR DRIVING PHASE SEQUENCES**

The L297's translator generates phase sequences for normal drive, wave drive and half step modes. The state sequences and output waveforms for these three modes are shown below. In all cases the translator advances on the low to high transition of  $\overline{\text{CLOCK}}$ .

Clockwise rotation is indicated; for anticlockwise rotation the sequences are simply reversed.  $\overline{\text{RESET}}$  restores the translator to state 1, where ABCD = 0101.

**HALF STEP MODE**

Half step mode is selected by a high level on the  $\overline{\text{HALF/FULL}}$  input.

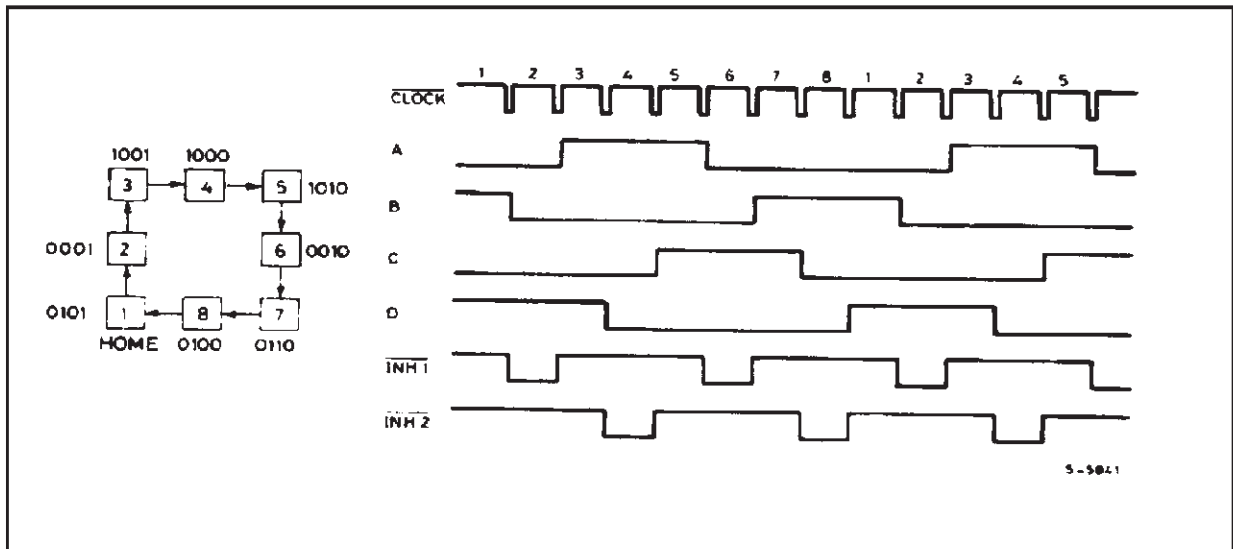

**NORMAL DRIVE MODE**

Normal drive mode (also called "two-phase-on" drive) is selected by a low level on the  $\overline{\text{HALF/FULL}}$  input when the translator is at an odd numbered state (1, 3, 5 or 7). In this mode the  $\overline{\text{INH1}}$  and  $\overline{\text{INH2}}$  outputs remain high throughout.

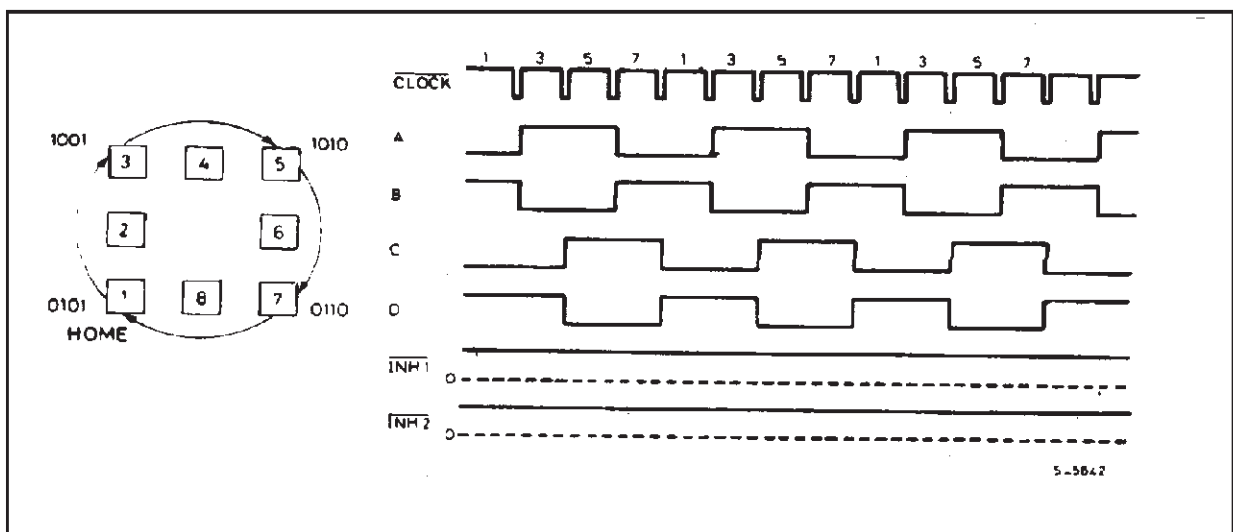

**MOTOR DRIVING PHASE SEQUENCES** (continued)

WAVE DRIVE MODE

Wave drive mode (also called "one-phase-on" drive) is selected by a low level on the HALF/FULL input when the translator is at an even numbered state (2, 4, 6 or 8).

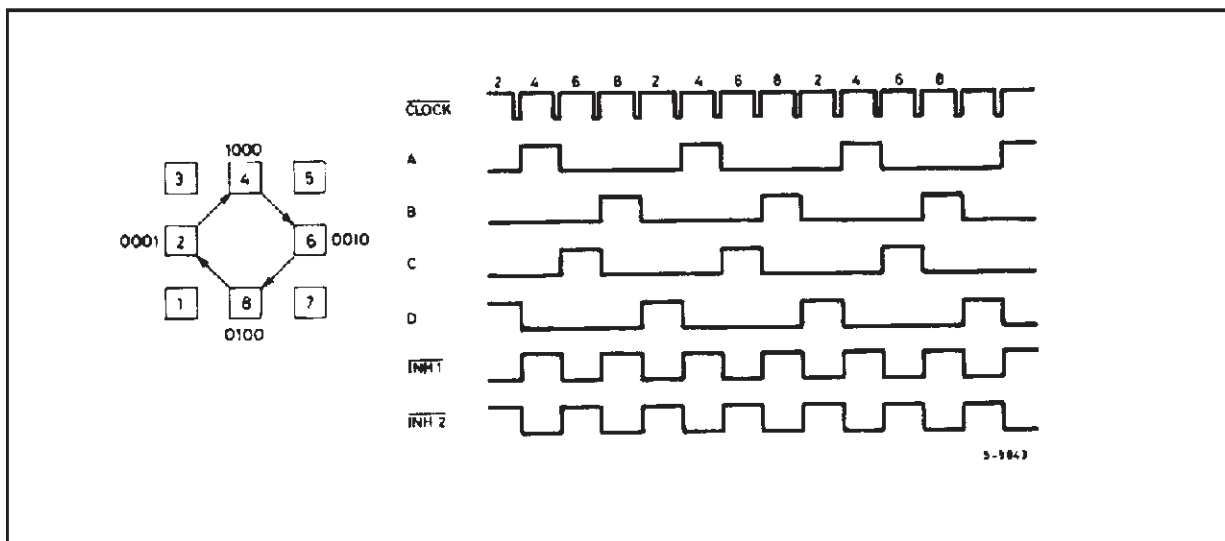

**ELECTRICAL CHARACTERISTICS** (Refer to the block diagram  $T_{amb} = 25^{\circ}\text{C}$ ,  $V_s = 5\text{V}$  unless otherwise specified)

Symbol	Parameter	Test conditions	Min.	Typ	Max.	Unit
$V_s$	Supply voltage (pin 12)		4.75		7	V
$I_s$	Quiescent supply current (pin 12)	Outputs floating		50	80	mA
$V_i$	Input voltage (pin 11, 17, 18, 19, 20)	Low			0.6	V
		High	2		$V_s$	V
$I_i$	Input current (pin 11, 17, 18, 19, 20)	$V_i = L$		100		$\mu\text{A}$
		$V_i = H$			10	$\mu\text{A}$
$V_{en}$	Enable input voltage (pin 10)	Low			1.3	V
		High	2		$V_s$	V
$I_{en}$	Enable input current (pin 10)	$V_{en} = L$			100	$\mu\text{A}$
		$V_{en} = H$			10	$\mu\text{A}$
$V_o$	Phase output voltage (pins 4, 6, 7, 9)	$I_o = 10\text{mA}$ $V_{OL}$			0.4	V
		$I_o = 5\text{mA}$ $V_{OH}$	3.9			V
$V_{inh}$	Inhibit output voltage (pins 5, 8)	$I_o = 10\text{mA}$ $V_{inhL}$			0.4	V
		$I_o = 5\text{mA}$ $V_{inhH}$	3.9			V
$V_{SYNC}$	Sync Output Voltage	$I_o = 5\text{mA}$ $V_{SYNC H}$	3.3			V
		$I_o = 5\text{mA}$ $V_{SYNC V}$			0.8	

## ELECTRICAL CHARACTERISTICS (continued)

Symbol	Parameter	Test conditions	Min.	Typ	Max.	Unit
$I_{leak}$	Leakage current (pin 3)	$V_{CE} = 7\text{ V}$			1	$\mu\text{A}$
$V_{sat}$	Saturation voltage (pin 3)	$I = 5\text{ mA}$			0.4	V
$V_{off}$	Comparators offset voltage (pins 13, 14, 15)	$V_{ref} = 1\text{ V}$			5	mV
$I_o$	Comparator bias current (pins 13, 14, 15)		-100		10	$\mu\text{A}$
$V_{ref}$	Input reference voltage (pin 15)		0		3	V
$t_{CLK}$	Clock time		0.5			$\mu\text{s}$
$t_S$	Set up time		1			$\mu\text{s}$
$t_H$	Hold time		4			$\mu\text{s}$
$t_R$	Reset time		1			$\mu\text{s}$
$t_{RCLK}$	Reset to clock delay		1			$\mu\text{s}$

Figure 1.

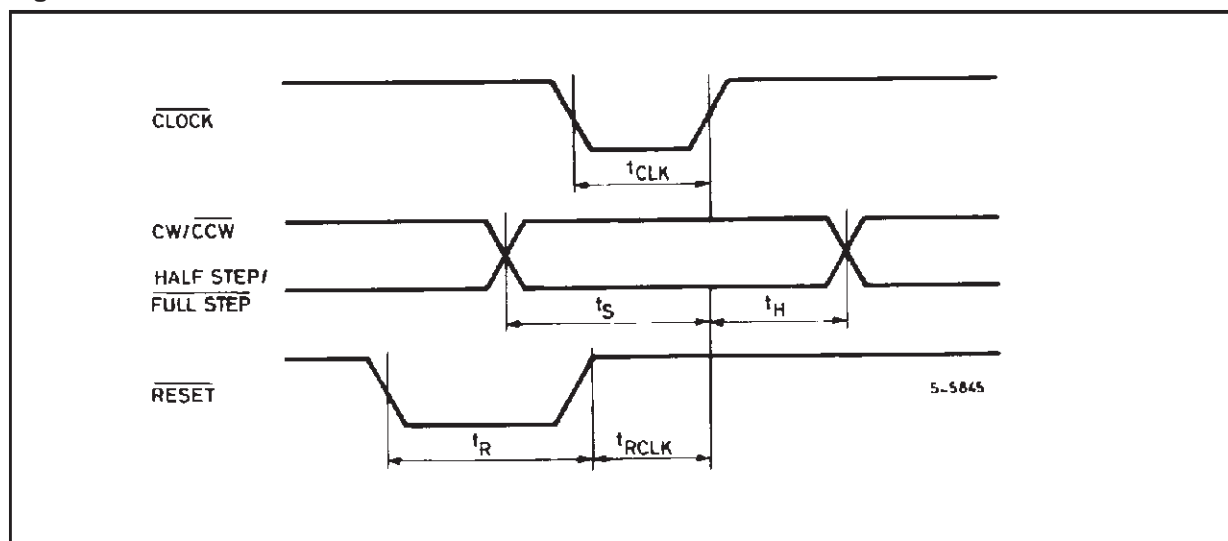

**APPLICATION INFORMATION**

**TWO PHASE BIPOLAR STEPPER MOTOR CONTROL CIRCUIT**

This circuit drives bipolar stepper motors with winding currents up to 2A. The diodes are fast 2A types.

**Figure 2.**

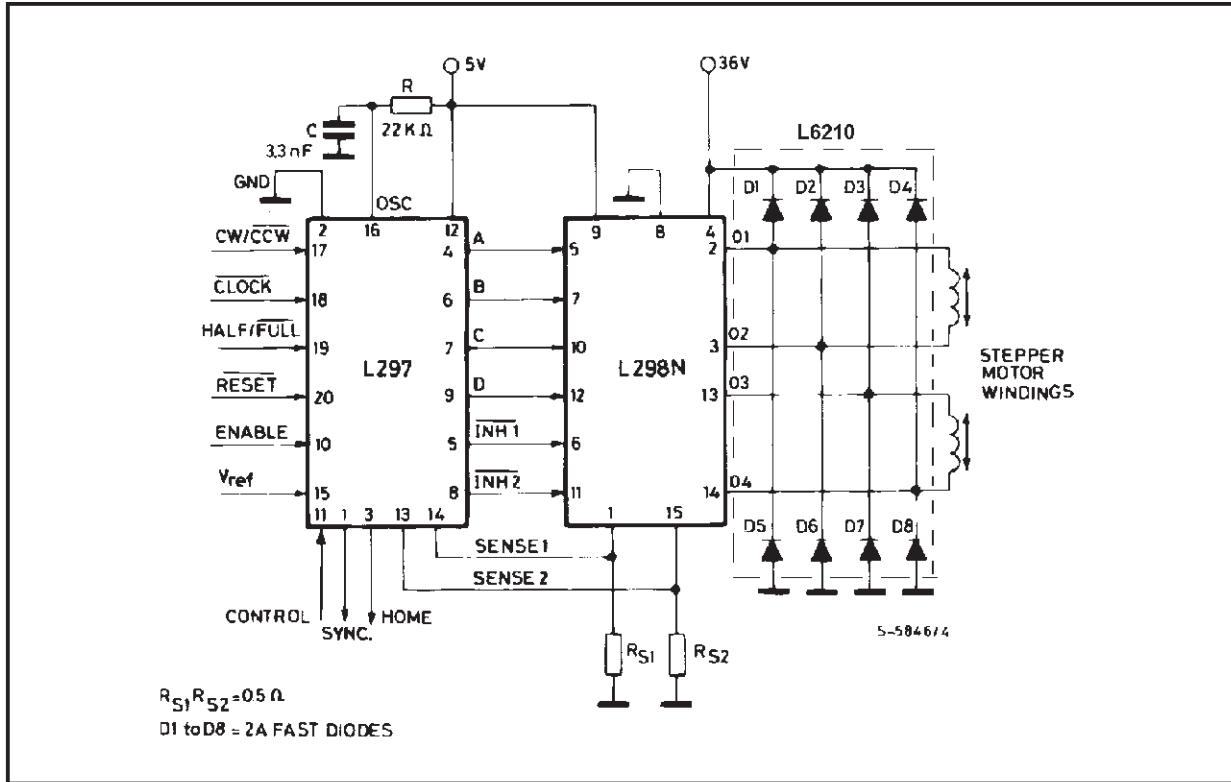

**Figure 3 : Synchronising L297s**

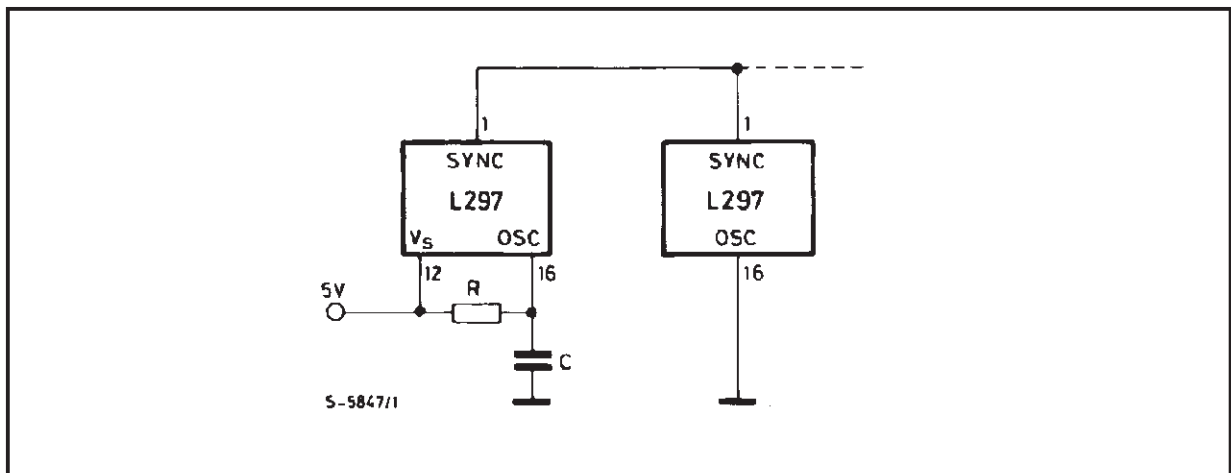



DIM.	mm			inch		
	MIN.	TYP.	MAX.	MIN.	TYP.	MAX.
a1	0.254			0.010		
B	1.39		1.65	0.055		0.065
b		0.45			0.018	
b1		0.25			0.010	
D			25.4			1.000
E		8.5			0.335	
e		2.54			0.100	
e3		22.86			0.900	
F			7.1			0.280
I			3.93			0.155
L		3.3			0.130	
Z			1.34			0.053

## OUTLINE AND MECHANICAL DATA

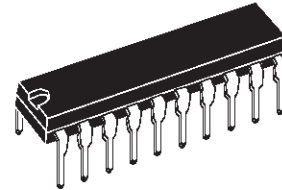

### DIP20

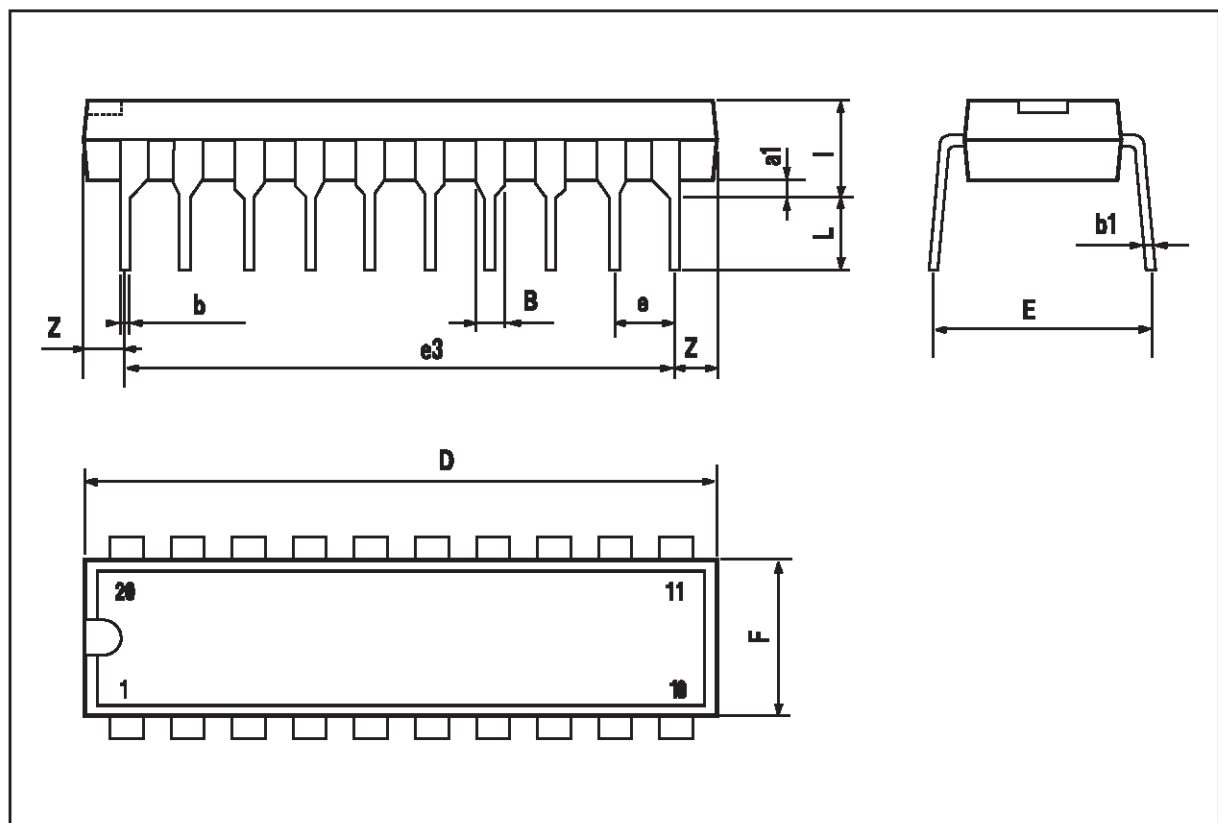

DIM.	mm			inch		
	MIN.	TYP.	MAX.	MIN.	TYP.	MAX.
A	2.35		2.65	0.093		0.104
A1	0.1		0.3	0.004		0.012
B	0.33		0.51	0.013		0.020
C	0.23		0.32	0.009		0.013
D	12.6		13	0.496		0.512
E	7.4		7.6	0.291		0.299
e		1.27			0.050	
H	10		10.65	0.394		0.419
h	0.25		0.75	0.010		0.030
L	0.4		1.27	0.016		0.050
K	0° (min.)8° (max.)					

**OUTLINE AND MECHANICAL DATA**

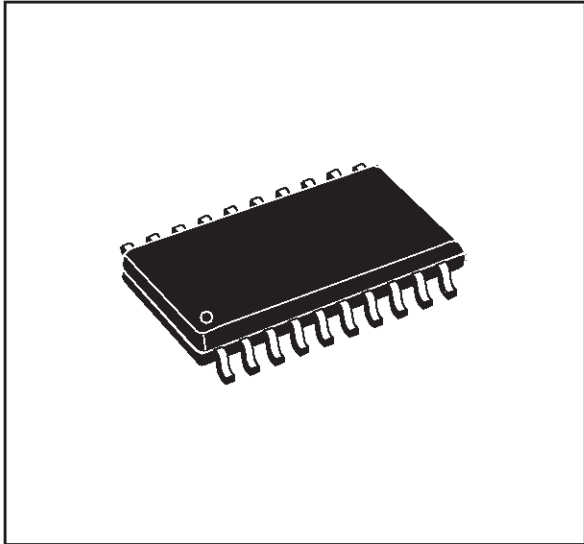

**SO20**

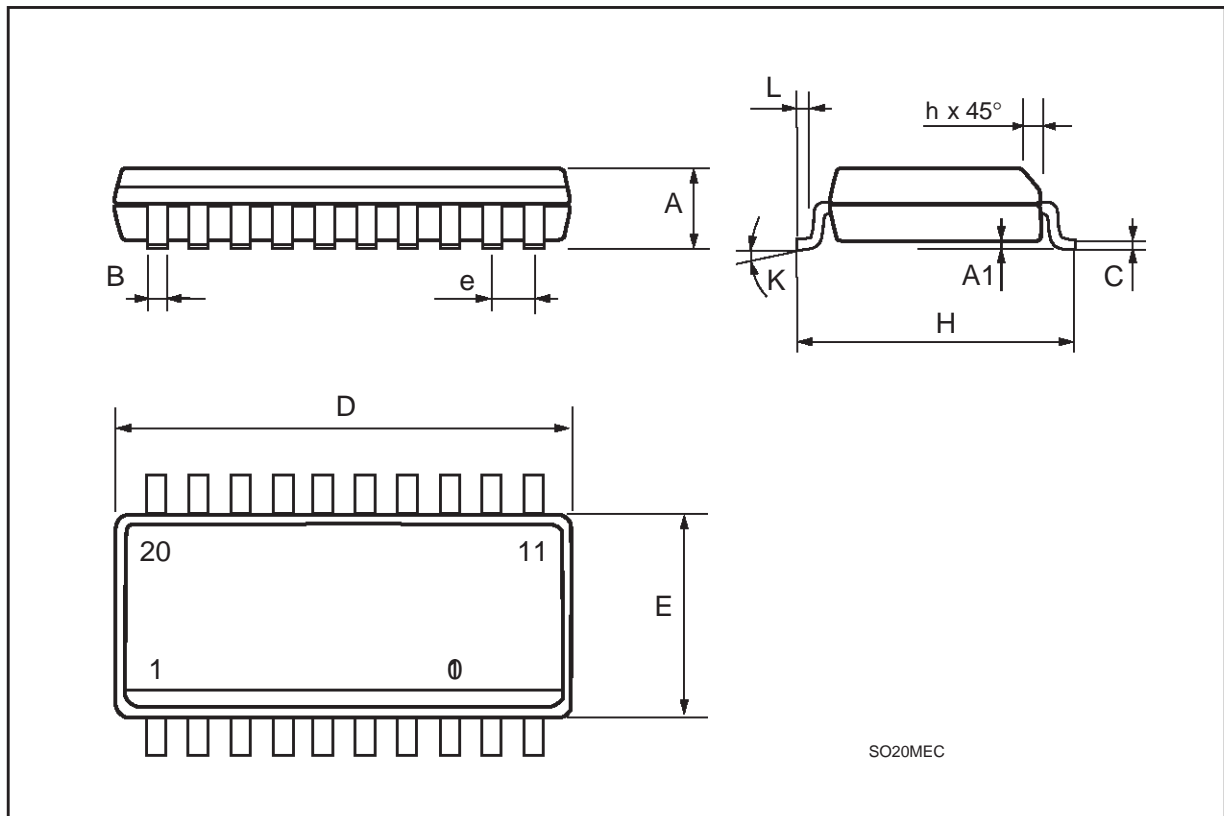

SO20MEC

Information furnished is believed to be accurate and reliable. However, STMicroelectronics assumes no responsibility for the consequences of use of such information nor for any infringement of patents or other rights of third parties which may result from its use. No license is granted by implication or otherwise under any patent or patent rights of STMicroelectronics. Specification mentioned in this publication are subject to change without notice. This publication supersedes and replaces all information previously supplied. STMicroelectronics products are not authorized for use as critical components in life support devices or systems without express written approval of STMicroelectronics.

The ST logo is a registered trademark of STMicroelectronics

© 2001 STMicroelectronics – Printed in Italy – All Rights Reserved

STMicroelectronics GROUP OF COMPANIES

Australia - Brazil - Canada - China - Finland - France - Germany - Hong Kong - India - Israel - Italy - Japan - Malaysia - Malta - Morocco - Singapore - Spain - Sweden - Switzerland - United Kingdom - United States.

<http://www.st.com>

