

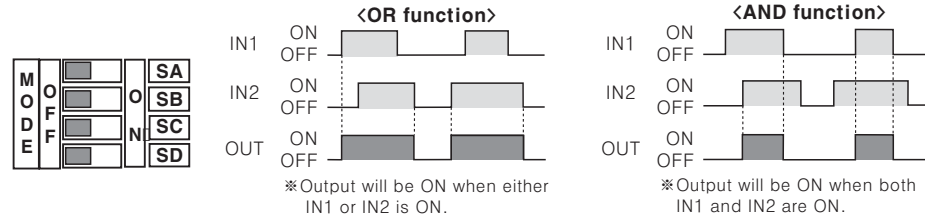

## Operation mode

### MODE 0 NORMAL MODE

: OUT will work according to input signal regardless Timer.



### MODE 1 ON-DELAY MODE

: OUT will be ON after setting time according to one of IN1 and IN2 is ON. When IN1 and IN2 are OFF, OUT will be OFF. (This is when input logic is OR)

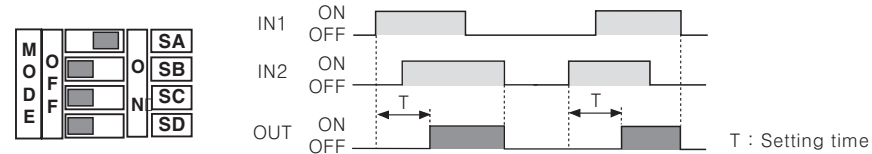

### MODE 2 OFF-DELAY MODE

: OUT will be ON at the same time when IN1 or IN2 is ON then OUT will be OFF after setting time according to IN1 or IN2 is OFF. (This is when input logic is OR)

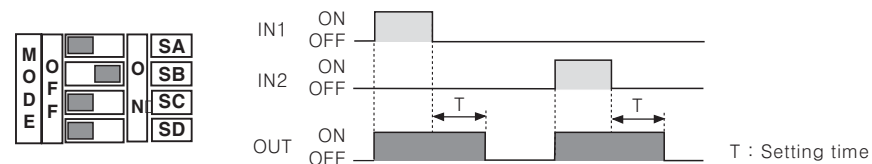

### MODE 3 ONE-SHOT DELAY MODE

: OUT will be ON at the same time with IN1 or IN2 is ON then OUT will be OFF after setting time. (This is when input logic is OR)

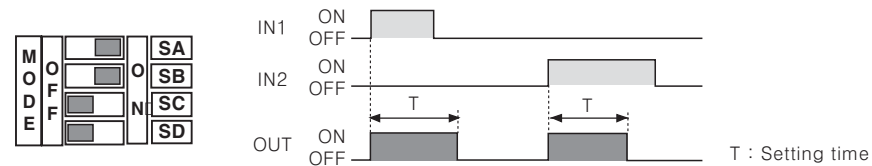

### MODE 4, 5 FLICKER MODE / FLICKER ONE-SHOT MODE

: OUT will be ON after setting time for IN1 input then it is flickering and OUT will be flickering after setting time from ON. But, in case of One-shot Mode, output time(Ts) will be selected by S/W.

(S/W: Ts= Approx. 10ms, NORM: Ts= Approx. 100ms)

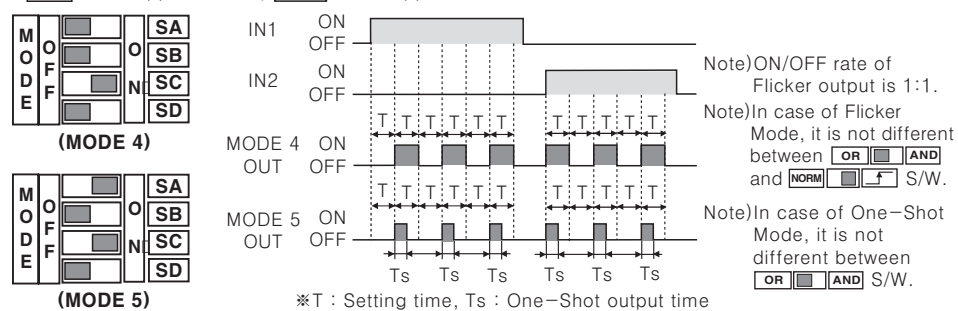

### MODE 6 LOW-SPEED DETECTION MODE

: OUT will be ON when input signal (IN1) is longer than setting time by comparing it to the setting time by one cycle.

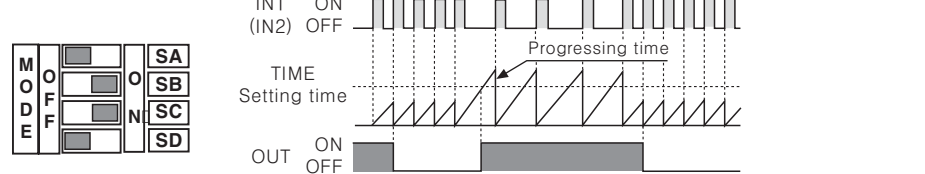

Note) Above is when input logic is OR and it will be the same by using IN2 input signal terminal instead of IN1.

Note) When use MODE 6 as above, be sure that OUT will be work at the same time with power supply.

### MODE 7 HIGH-SPEED DETECTION MODE

: OUT will be ON when input signal (IN1) is shorter than setting time by comparing it to the setting time by one cycle.

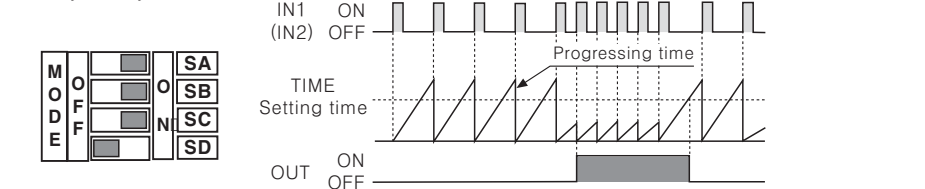

Note) Above is when input logic is OR and it will be the same by using IN2 input signal terminal instead of IN1.

## TIME S/W function(MODE 1 ~ MODE 7)

: Set the setting time by TIME S/W(T1, T2) and front TIME VOLUME(ADJ).

MODE	MODE 1 to MODE 7		MODE 6 to MODE 7	
	Setting time range	Input frequency	rpm	
OFF	0.01 to 0.1sec	100 to 10Hz	6,000 to 600rpm	
ON	0.1 to 1sec	10 to 1Hz	600 to 60rpm	
OFF	1 to 10sec	1 to 0.1Hz	60 to 6rpm	
ON	10 to 100sec	0.1 to 0.01Hz	6 to 0.6rpm	

※ Range of operating rpm is 1 pulse per 1 revolution

※ When the pulse is increasing per 1 revolution, range of operating rpm is decreasing.

### MODE 8 Flip-Flop MODE [OUT LATCH operation]

: When IN1 signal is input then the Flip-Flop output will be ON(SET). When the IN2 signal is input, Flip-Flop Signal will be OFF(RESET).

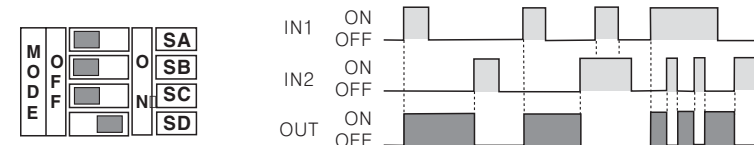

Note) IN2 will be the first of input signal.

Note) It is not different between OR AND and NORM S/W.

Note) There is no Timer function in Flip-Flop Mode, therefore use this unit with Time S/W(T1, T2) are OFF.

## ENCODER MODE(MODE 9 ~ MODE 11)

- There should be 90° phase difference between IN1 and IN2 for input terminal.
- Please connect A phase output of encoder to IN1 and B phase output of encoder to IN2, when use NPN open collector or Totem-pole output type of encoder with PA10-U.
- In this case, turned to CW direction detection signal(O.C OUT2, OUT) output of PA10-U will be OFF.
- There are output function of Pulse(O.C OUT1) has been multiplied(×1, ×2, ×4 times) against input signal and Direction detection output(O.C OUT2, OUT) function which detects direction of encoder rotation in Encoder mode.
- Be sure to Input speed(cps) of connected equipment due to pulse width of O.C OUT1 is short.

S/W Selection: OR AND NORM S/W Selection: NORM INV Selection S/W can be set at any position.

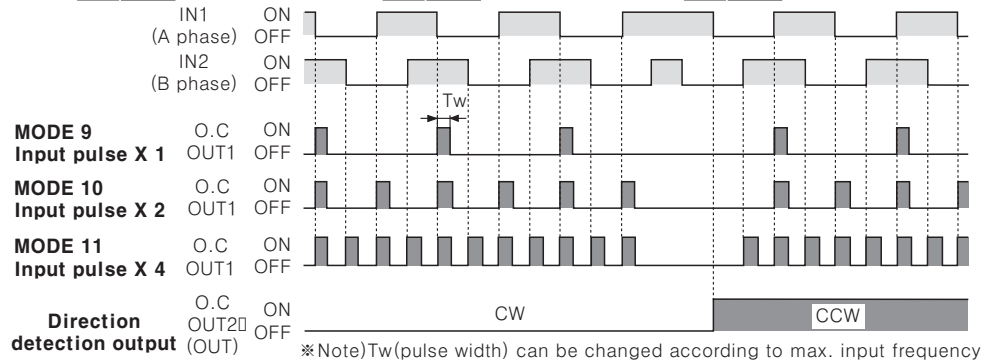
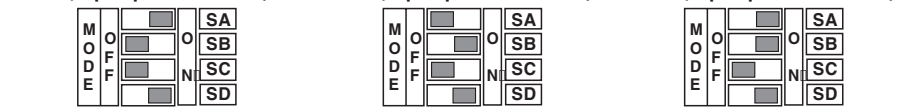

## TIME S/W function in Encoder mode

: TIME S/W is to convert output pulse width(Tw).

TIME S/W	Max. input frequency	Output pulse width(Tw)	Input speed of connected equipment(cps)
OFF	100kHz	Approx. 0.5μs	Min. 2000kHz(2,000kcps)
ON	10kHz	Approx. 5μs	Min. 200kHz(200kcps)
OFF	1kHz	Approx. 50μs	Min. 20kHz(20kcps)
ON	100Hz	Approx. 500μs	Min. 2kHz(2kcps)

## Factory specification for S/W

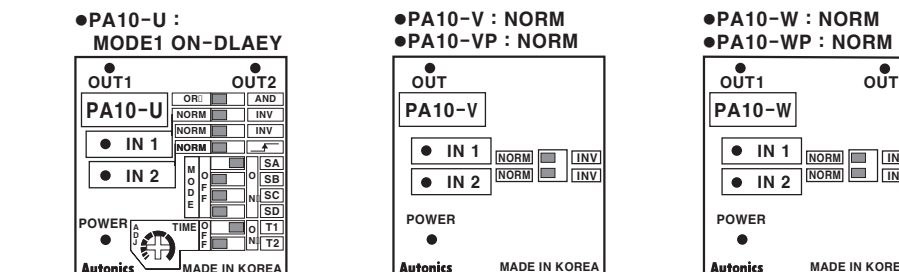

## Output

○ Load connection  
Ability to reduce noise generating if install surge absorber between inductive loads(Motor, Solenoid, etc) as Picture1. When use DC Relay for load, please install a diode at relay coils as Picture 2. (Be sure to power polarity)

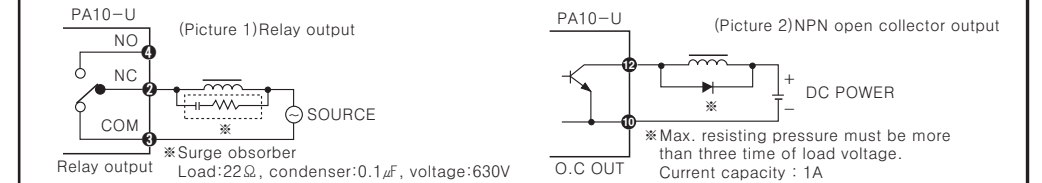

## Function diagram

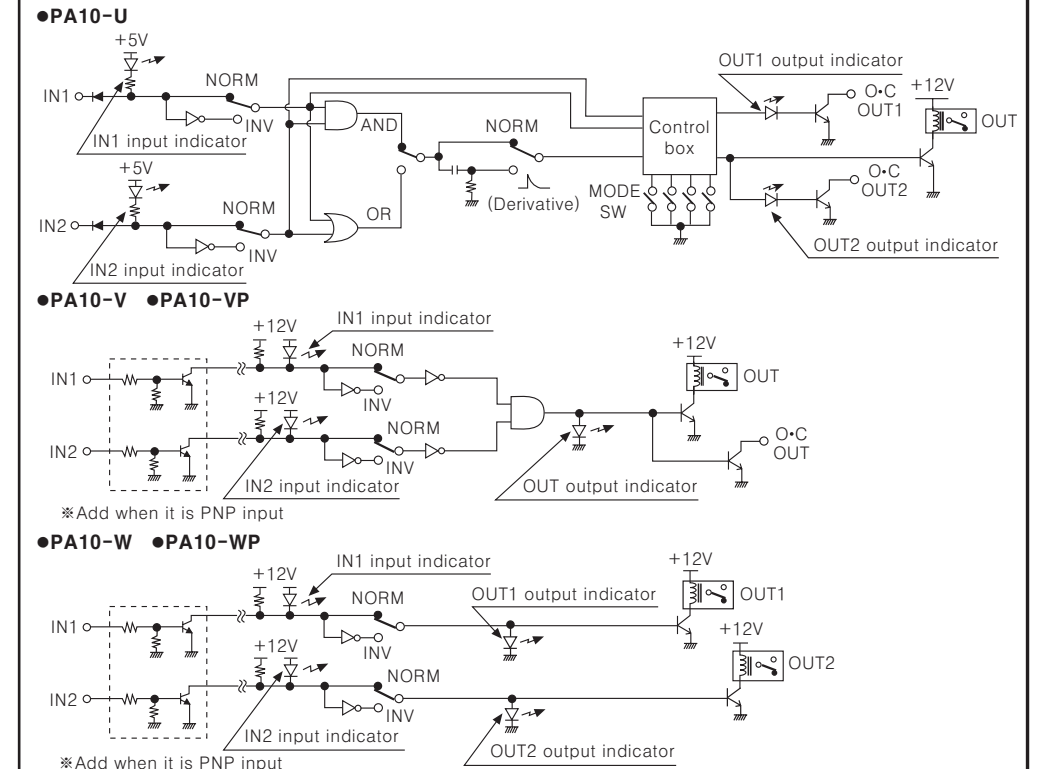

## Caution for using

- Power
    - The inner circuit voltage starts to rise up for the first 100ms after power on, the input may not work at this time. And also the inner circuit voltage drops down for the last 500ms after power off, the input may not work at this time.
    - Please use the power within rating power and apply or cut the power at once to prevent from chattering.
  - Input signal line
    - Shorten the cable distance between the sensor and this product.
    - Please shielded wire for input signal needed to be long.
    - Please wire input signal line separated from power line.
  - When test dielectric voltage and insulation resistance of the control panel with this unit installed.
    - Please isolate this unit from the circuit of control panel.
    - Please make all terminals of this unit short-circuited.
  - Do not use this unit at below places.
    - Place where there are severe vibration or impact.
    - Place where strong alkalis or acids are used.
    - Place where there are direct ray of the sun
    - Place where strong magnetic field or electric noise are generated.
  - Installation environment
    - It shall be used indoor
    - Altitude Max. 2000m
    - Pollution Degree 2
    - Installation Category II.
- ※ It may cause malfunction if above instructions are not followed.

## Main products

- COUNTER
- TIMER
- TEMPERATURE CONTROLLER
- PANEL METER
- TACHOMETER/LINE SPEED METER/ PULSE METER
- DISPLAY UNIT
- PROXIMITY SENSOR
- PHOTOELECTRIC SENSOR
- FIBER OPTIC SENSOR
- PRESSURE SENSOR
- ROTARY ENCODER
- SENSOR CONTROLLER
- POWER CONTROLLER
- STEPPING MOTOR & DRIVER & CONTROLLER

**Autonics Corporation**  
http://www.autonics.net

HEAD QUARTER :  
41-5, Yongdang-ri, Ungsang-eup, Yangsan-si, Gyeongnam, Korea 626-847

INTERNATIONAL SALES :  
512 Ansung B/D, 410-13, Shindorim-dong, Guro-gu, Seoul, Korea 152-070  
TEL: 82-2-2679-6585 / FAX: 82-2-2679-6556  
E-mail : sales@autonics.net

NO20030813-EP-E-10-026C